

# ELECTRICAL COMMUNICATION

JULY

No. 1

1933

VOL. 12

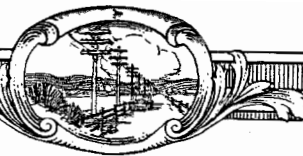

# ELECTRICAL COMMUNICATION

A Journal of Progress in the  
Telephone, Telegraph and Radio Art

H. T. KOHLHAAS, Editor

## EDITORIAL BOARD

E. A. Brofos    P. K. Condict    G. Deakin    E. M. Deloraine    P. E. Erikson    John W. Foard  
James E. Fullam    F. Gill    Frank C. Page    H. M. Pease    G. E. Pingree

Published Quarterly by the

## *International Standard Electric Corporation*

Head Offices

67 BROAD STREET, NEW YORK, N. Y., U. S. A.

European General Offices

CONNAUGHT HOUSE, ALDWYCH, LONDON, W. C. 2, ENGLAND

G. E. Pingree, President

S. G. Ordway, Secretary

Joseph A. Redegeld, Treasurer

Subscription, \$3.00 per year; single copies 75 cents

Volume XII

JULY, 1933

Number 1

## CONTENTS

	PAGE
PRODUCTION AND UTILIZATION OF MICRO-RAYS.....	3
<i>By A. G. Clavier</i>	
THE CHILDHOOD OF BROADCASTING IN NORWAY.....	12
<i>By E. A. Brofos</i>	
A TELEGRAPH DISTORTION MEASURING SET.....	15
<i>By V. J. Terry, B.Sc. and C. H. W. Brookes-Smith</i>	
MEASUREMENT OF THE MUTUAL IMPEDANCE OF CIRCUITS WITH EARTH RETURN.....	24
<i>By John Collard, Ph.D.</i>	
PROCEEDINGS OF THE INTERNATIONAL CONSULTATIVE COM- MITTEE ON LONG DISTANCE TELEPHONY, PARIS, SEPTEM- BER 14-21, 1931.....	33
A CONTROLLED SINGLE MOTION SWITCH SYSTEM OPERATING IN THE LONDON AREA.....	34
<i>By J. H. E. Baker, B.S., A.C.G.I., A.M.I.E.E. and E. P. G. Wright, A.M.I.E.E.</i>	
7-A2 ROTARY AUTOMATIC TELEPHONE SYSTEM—PART II. . . .	43
<i>By L. Schreiber and W. Hatton</i>	
TELEPHONE AND TELEGRAPH STATISTICS OF THE WORLD. . . .	51

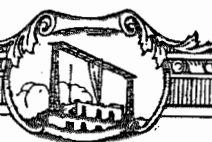



*An unusual view of the Headquarters Building of the International Telephone and Telegraph Corporation, New York, photographed from the shadows of the elevated railroad line of the Third Avenue Railway Company*

# Production and Utilization of Micro-Rays

By A. G. CLAVIER

*Les Laboratoires, Le Matériel Téléphonique*

THE reader will recollect the statements which appeared both in the daily and technical press after the successful demonstration between Dover and Calais on March 31st, 1931, of the duplex telephone link operating on a wavelength of the order of 18 cm.<sup>1</sup> The success of this demonstration made engineers engaged in the communication art realize what part these very short waves might play eventually in the general system of communication.

An order has since been received for a permanent link operating between the aerodromes of Lympne and St. Inglevert across the Straits of Dover. This will be the first commercial application of the system.

A description of this link will be published in the near future in *Electrical Communication*, but it was felt that a paper dealing with the methods used to produce oscillations of a wavelength shorter than 20 cm. would be of immediate interest. These waves have come to be generally known under the name of "micro-rays" and we will use this term throughout this text.

The main property which distinguishes these waves from the longer ones comes from the fact that use may be made of phenomena which are more commonly considered as optical, such as reflection, refraction and diffraction.

There is of course no sharp upper limit to the wavelength of micro-rays; we have mentioned 20 cm. simply because for longer waves the dimensions of reflectors become so large as to be impracticable or too expensive. In fact, even for the very short wavelengths which we are considering, the dimensions of the electro-optical systems which can be used remain much smaller in respect of the wavelength than they would be in the light spectrum. It is, on the other hand, very easy to obtain polarised sources in the shape of half-wave antennae. Indeed it may be said that the technician finds himself in

this field half-way between optics and radio-electricity.<sup>2</sup>

## 1. Description of the Tube Structure

The tube used is made of three electrodes having a cylindrical symmetry. The filament is the axis of the structure and is made of pure tungsten. A helicoidal electrode is centered on the filament and is made of some 20 turns of tungsten wire. It is called the "oscillating electrode" for reasons which will be explained later. The external electrode is a molybdenum cylinder and will be referred to as the "reflecting electrode."

The two extremities of the oscillating electrode are connected to a transmission line which leads to some sort of radiating element. The simplest case is when the transmission line is of the parallel conductor type and the radiating element constituted by a small length of wire placed at right angles to the transmission line.

When this system is correctly adjusted there is a current maximum in the radiating element. This element remains small as compared with the wavelength and functions as a theoretical "doublet." That is to say the amplitude of the high frequency current is substantially the same in all points of this doublet at any particular time.

Experiment shows that when the transmission line remains short the radiation of the doublet is predominant and all other radiation effects in the system may be considered as secondary.

A positive voltage  $E_0$  of about 250 volts is applied to the oscillating electrode by means of a connection which is placed perpendicularly to the doublet at its middle point. The reflecting electrode is polarised by means of a battery  $E_r$  negative with respect to the filament battery which is an ordinary 6 volts A battery.

<sup>2</sup>Articles on ultra-short wave oscillations have been published by many authors, among which we may quote: Barkhausen, Kurz, Scheibe, Gutton, Pierret, Beauvais, Hollmann, Gill, Morrell, Benham, etc.

<sup>1</sup>"Micro-Ray Radio," *Electrical Communication*, July, 1931.

A schematic of the tube structure is shown in Figure 1 and a photographic view in Figure 2. Figure 3 shows the apparatus which has been used to study the properties of the tube and its doublet. The presence of oscillations is proved by a wave-meter which has a very sharply tuned circuit. A description of this wave-meter will be found in the February 1932 number of *L'Onde Electrique*.<sup>3</sup>

## 2. Production of Oscillations

The oscillations are always produced in the part of the static characteristic curves of the tube corresponding to the voltage saturation of the filament by the D.C. voltage of the oscillating electrode.

The electrons are attracted by the positively polarised oscillating electrode. A certain number fall directly on this electrode. Others travel through the meshes of the oscillating electrode and fall into the space between the oscillating electrode and the reflecting electrode. These electrons are submitted to a retarding field, lose their speed and finally turn back to the

<sup>3</sup>R. H. Darbord, "Réflecteurs et Lignes de Transmission pour Ondes Ultra-Courtes."

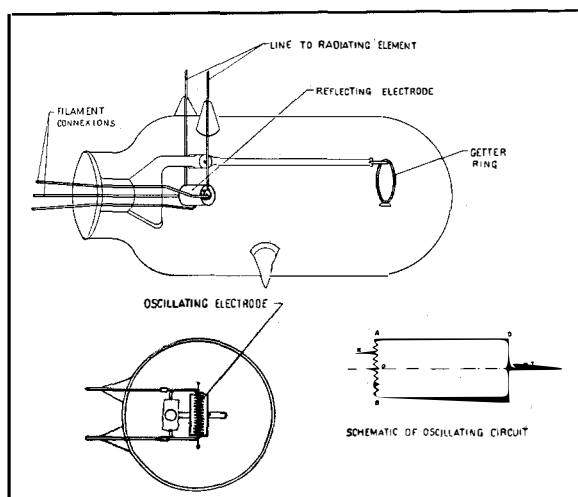

Figure 1—Micro-Ray Oscillating Tube.

oscillating electrode. On their way back, some fall again on the wire of the oscillating electrode, while others reach the filament region and are not distinguishable from other electrons which leave the filament for the first time.

Neglecting all initial velocity effects and space charge effects we will now show that when a high frequency voltage appears along the oscillating electrode the total number of electrons which

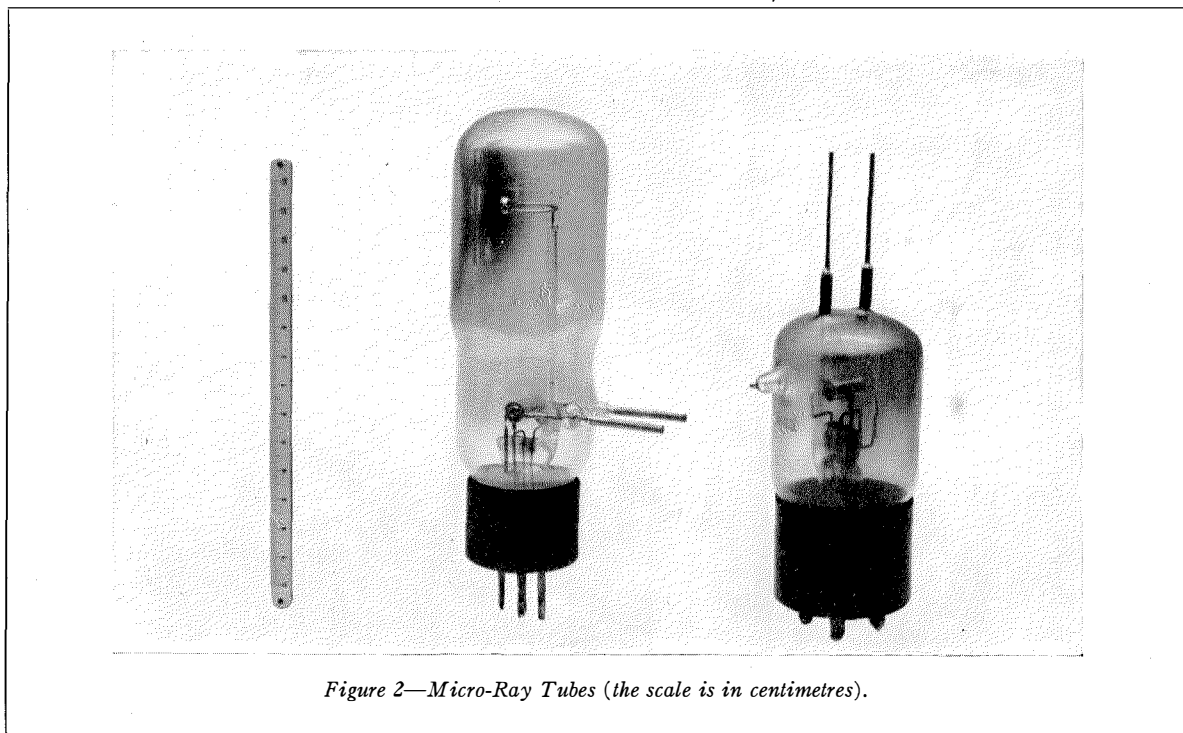

Figure 2—Micro-Ray Tubes (the scale is in centimetres).



fall at any point either directly or after being reflected will not always be the same and that at any point of the oscillating electrode there will consequently be a leakage current made up of an average D.C. value and a high frequency component which will not be in phase with the original high frequency voltage along the oscillating electrode. It is this dephased leakage current which makes it possible to sustain the ultra-short wave oscillations within the tube.

### 3. Case of Plane Electrodes

Let us first consider the simpler case when the cathode and reflecting electrode have the shape of parallel planes. The oscillating electrode is made of wire in a plane parallel to the other electrodes. Let us call  $r_a$  the thickness of the cathode,  $r_o$  the distance from the radius to the oscillating electrode, and  $r$  any radius between  $r_a$  and  $r_o$ . Although  $r_a$  plays no part in the plane case, it is introduced to maintain the same form as in the cylindrical electrode case. We assume that the oscillating electrode is oscillating. Opposite a certain point X of this electrode the voltage will be:

$$E_o \frac{r - r_a}{r_o - r_a} (1 + m_x \cos \omega t) \quad (1)$$

where  $m_x$  is a small quantity equal to the ratio of the assumed amplitude of the high frequency oscillation at point x to the D.C. potential impressed on the oscillating electrode and where

$$\omega = \frac{2\pi}{T} \quad (2)$$

$T$  being the period of oscillation. We assume that the speed of the electrons is considerably smaller than the speed with which the electric field is propagated. From the fundamental equation:

$$m \frac{d^2 r}{dt^2} = \frac{\epsilon E_o}{r_o - r_a} (1 + m_x \cos \omega t) \quad (3)$$

where  $m$  is the mass of the electron and  $\epsilon$  its charge, we find by means of two integrations:

$$\begin{aligned} \frac{2m(r_o - r_a)^2}{\epsilon E_o} &= (t_o - t_a)^2 - \frac{2m_x}{\omega} (t_o - t_a) \sin \omega t_a \\ &- \frac{2m_x}{\omega^2} (\cos \omega t_o - \cos \omega t_a) \end{aligned} \quad (4)$$

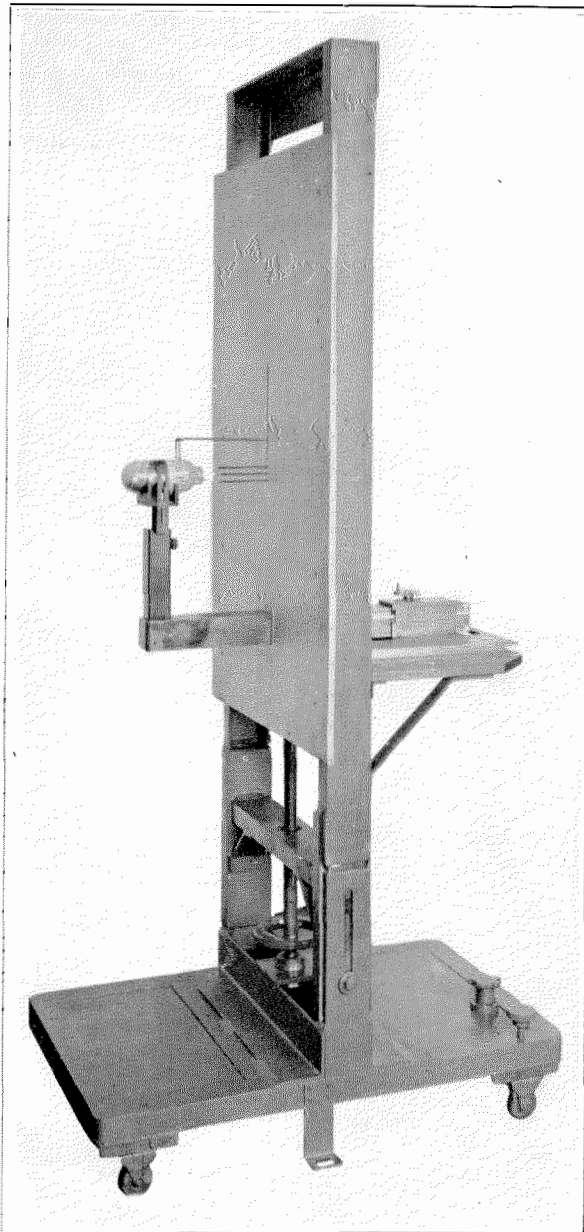

Figure 3—Testing Stand for Micro-Ray Tubes.

in which  $t_a$  is the time when the electron leaves the cathode and  $t_o$  the time when it reaches the oscillating electrode. If there were no oscillations, the time of transit to the oscillating electrode would be given by:

$$t_o - t_a = \sqrt{\frac{2m}{\epsilon E_o}} (r_o - r_a) = A \quad (5)$$

As  $m_x$  is assumed to be a very small quantity, as it at any rate should be when we consider the initial phenomena, we find an approximate value of the time of transit under dynamic conditions by replacing  $t_o - t_a$  by  $A$  in equation 4, which finally leads us to

$$t_1 = A \left( 1 + \frac{m_x}{\omega A} \sin \omega t_a - \frac{2m_x}{\omega^2 A^2} \sin \frac{\omega A}{2} \sin \omega \left( t_a + \frac{A}{2} \right) \right) \quad (6)$$

$t_1$  is the time which electrons leaving the cathode at time  $t_a$  take to reach the oscillating electrode under dynamic conditions. Equation 6 shows that it fluctuates around the value  $A$ , which is the time of transit for static conditions. In this process, it will be seen that the density of electrons falling on point  $X$  will be variable with time according to the change of the time of transit between the cathode and the oscillating electrode.

One electron leaving the filament at time  $t_a$  will reach the oscillating electrode at time  $t_a + t_1$ . Another starting at  $t_a + \delta t_a$  will reach the oscillating electrode at time  $t_a + t_1 + \delta t_a + \delta t_1$ . Let the number of electrons sent off in interval  $\delta t_a$  be  $\alpha \cdot \delta t_a$ . The density of the direct electron current falling on a length  $dx$  containing point  $X$  will be equal to

$$\frac{\alpha \cdot \delta t_a}{\delta t_a + \delta t_1} = \alpha \frac{1}{1 + \frac{\delta t_1}{\delta t_a}} \quad (7)$$

and the direct electronic current on length  $dx$  may finally be written:

$$i_{dx} = \alpha \left[ 1 - \left( 1 - \frac{\sin \omega A}{\omega A} \right) m_x \cos \omega t_a - \frac{2 \sin^2 \frac{\omega A}{2}}{\omega A} m_x \sin \omega t_a \right] \cdot dx \quad (8)$$

Therefore, the high frequency component of this current is not in phase with the high frequency voltage at the point of the oscillating electrode under consideration (see equation 1). The phase difference as well as the amplitude of this high frequency component depend on the average time of transit of the electrons, i.e., on the dimensions of the tube and the D.C. voltage applied on the oscillating electrode.

#### 4. Reflected Electron Current to the Oscillating Electrode (Plane Electrodes)

Those electrons which pass through the meshes of the oscillating electrode, progressively lose their speed and finally come to rest in a region which may be considered as a virtual cathode, situated somewhere between the oscillating electrode and the reflecting electrode, the radius of which will be called  $r_r$ . The distance  $r_x$  where this virtual cathode will exist is not very different from the radius where the electrons would stop if there were no oscillation.

When the electrons cross the plane of the oscillating electrode their speed has an average value given by

$$\frac{1}{2} m v_o^2 = \epsilon E_o \quad (9)$$

Neglecting the effect of any space charge, the field between the oscillating electrode and the reflecting electrode will correspond at any radius  $r$  to the equation:

$$E = E_o - (E_o + E_r) \frac{r - r_o}{r_r - r_o} \quad (10)$$

so that the distance  $r_x$  will be given by

$$\frac{1}{2} m v_o^2 = \epsilon E_o = \epsilon \frac{E_o + E_r}{r_r - r_o} (r_x - r_o). \quad (11)$$

We have then for this virtual cathode the same process as we had for the real filament. The time of the transit of electrons between the virtual cathode and the oscillating electrode will fluctuate around a value  $B$  which corresponds to static conditions and will give rise to a reflected electron current variable with time, the value of which may be written

$$i_{r_x} = \beta \left[ 1 - \left( 1 - \frac{\sin \omega B}{\omega B} \right) m_x \cos \omega t_a - \frac{2m_x \sin \frac{2\omega B}{2}}{\omega B} \sin \omega t_a \right] dx \quad (12)$$

where  $\beta$  is a constant characterising the emission of the virtual cathode as  $\alpha$  did for the real filament.

The factors  $\alpha$  and  $\beta$  give the relative importance of the direct and reflected current in the

total electron current falling on point X of the oscillating electrode.

### 5. Total Electron Current and Negative Leakance Effect

At the point of the oscillating electrode which we have considered there will be a leakage current per length dx equal to the sum of those parts of the direct electron current and reflected electron current that fall on the oscillating electrode. That is to say this current will be

$$i_{dx} + i_{rx} \tag{13}$$

As the filament gives its saturation current, the integration of the mean value of the above expression along the oscillating electrode equals the saturation current  $I_o$ , i.e.,

$$(\alpha + \beta) \Lambda = I_o \tag{14}$$

where  $\Lambda$  is the length of the oscillating electrode.

The electron current which falls on dx can finally be written

$$i_x = \frac{I_o}{\Lambda} dx - \frac{I_o}{\Lambda} m_x \cos \omega t$$

$$\left[ \left( 1 - \frac{\sin \omega A}{\omega A} \right) \frac{\alpha}{\alpha + \beta} + \left( 1 - \frac{\sin \omega B}{\omega B} \right) \frac{\beta}{\alpha + \beta} \right] dx$$

$$- \frac{I_o}{\Lambda} m_x \sin \omega t$$

$$\left[ \frac{2 \sin^2 \frac{\omega A}{2}}{\omega A} \frac{\alpha}{\alpha + \beta} + \frac{2 \sin^2 \frac{\omega B}{2}}{\omega B} \frac{\beta}{\alpha + \beta} \right] dx \tag{15}$$

This indicates that at point X of the oscillating electrode there exists a negative leakance per unit length equal to

$$\frac{I_o}{\Lambda E_o} \left[ \left( 1 - \frac{\sin \omega A}{\omega A} \right) \frac{\alpha}{\alpha + \beta} + \left( 1 - \frac{\sin \omega B}{\omega B} \right) \frac{\beta}{\alpha + \beta} \right] \tag{16}$$

This explains the possibility of oscillations being sustained provided the integrated effect of that negative leakance along the oscillating electrode more than compensates for the damping resistances in the oscillating circuit.

### 6. Case of Cylindrical Electrodes

The analysis of the above process for the plane

electrode case suggests a similar explanation for the actual case of cylindrical electrodes.

In the space between the filament and the oscillating electrode the distribution of potential will be

$$E_o \frac{\log \frac{r}{r_a}}{\log \frac{r_o}{r_a}} \tag{17}$$

and fundamental equation 3 becomes

$$m \frac{d^2 r}{dr^2} = \frac{\epsilon E_o}{r \log \frac{r_o}{r_a}} (1 + m_x \cos \omega t) \tag{18}$$

It is thus seen that the case is rather widely different from the plane electrode case, as the static electric field strength varies considerably between the filament and the oscillating electrode, in fact in the ratio of  $\frac{r_o}{r_a}$  which, in the case of the tubes we have mainly experimented on, is equal to 24.

As equation 18 leads to mathematical difficulties, we will simply assume that, as before, the density of electrons per length dx of the oscillating electrode will have a high frequency component giving a leakance g ( $\omega A$ ) without presupposing the sign of this quantity.

In the space between the oscillating electrode and the virtual cathode, the potential is distributed according to equation

$$E_o - E_o \frac{\log \frac{r}{r_o}}{\log \frac{r_x}{r_o}} = E_o \frac{\log \frac{r_x}{r}}{\log \frac{r_x}{r_o}} \tag{19}$$

and the static field strength varies much less than in the space between the real filament and the oscillating electrode; in fact, for the type of tube we are considering, it varies in the ratio of 7 to 4. We thus approximate the plane electrode case much more closely and can reasonably assume that the fluctuating density of electrons due to the reflected current will lead to a conductance g ( $\omega B$ ), which will be a negative quantity.



We believe that oscillations occur in the system because the total conductance

$$g(\omega A) + g(\omega B) \quad (20)$$

is negative when the voltages applied to the tube are suitable, and oscillations will be sustained in this case as in the plane electrode case provided the effect of this negative leakance along the length of the oscillating electrode more than compensates for the damping resistances in the oscillatory circuit.

This view is strongly supported by the experimental investigation of the tube properties, to which we will now turn our attention.

### 7. Constant Frequency Curves

We have found that for a certain external circuit, that is to say for a definite length of the transmission line leading to the doublet, there is one particular frequency for which the tube gives its maximum output. To find this optimum frequency we adjust the wave-meter for different wavelengths in a suitable range and for each wavelength adjust the voltages of the tube for maximum output, checking each time to ascertain that the maximum deflection of the galvanometer is not due to differences in amplitude for different frequencies. It is soon found that a particular setting is much better than any other—it corresponds to the above-mentioned optimum frequency.

For this optimum frequency we now plot what we call the constant frequency curve. This curve gives the relation which must exist between the biasing voltage on the reflecting electrode and the voltage on the oscillating electrode to produce the optimum frequency. The usual shape of such a curve is given in Figure 4.

The explanation we have given for the existence of a high frequency component in the leakage current along the oscillating electrode readily gives an explanation for the constant frequency curves. For any given value of the voltage on the oscillating electrode, A will have a fixed value and the energy which will be available in the system for sustaining the oscillations will depend on B. The best condition will correspond to the maximum negative value of

$$g(\omega A) + g(\omega B) \quad (21)$$

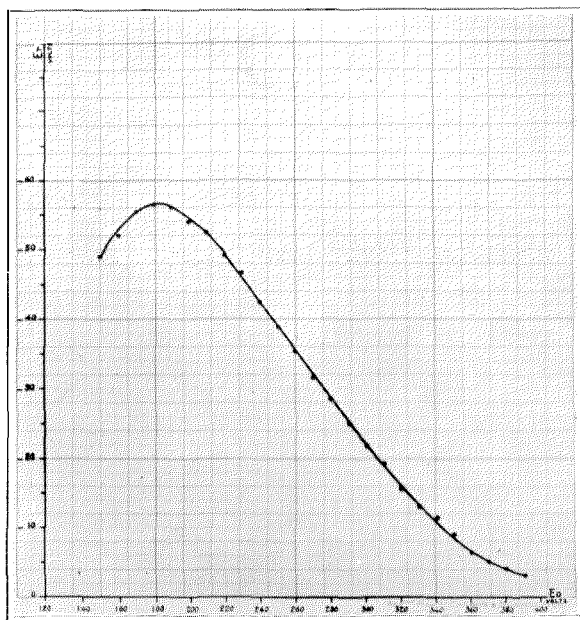

Figure 4—Constant Frequency Curves.

and, as the first part is fixed, to the maximum negative value of

$$g(\omega B),$$

i.e., from equation 16 (in the case of plane electrodes)  $\omega B = \frac{3\pi}{2}$  approximately. (22)

This means that for each particular adjustment the biasing voltage on the reflecting electrode will have to be adjusted so as to give a particular constant value to the average time of transit of electrons between the virtual cathode and the oscillating electrode. This average time of transit can be easily calculated by equating the kinetic energy of the electron to the product of the charge and the potential drop. It is thus found that

$$B = \frac{1}{\sqrt{\frac{2 \epsilon E_0}{m}}} \int_{r_0}^{r_x} \frac{dr}{\sqrt{1 - \frac{\log \frac{r}{r_0}}{\log \frac{r_x}{r_0}}} \quad (23)$$

It depends on both  $E_0$  and  $E_r$  which determines  $r_x$  and this gives the equation of the constant frequency curve, Fig. 6, as B should remain constant along the curve.

The extent to which such a conclusion is backed by experiment will be found in the following table:

EXPERIMENTAL QUANTITIES:		COMPUTED QUANTITIES:		OBSERVATIONS
$E_o$ , volts	$-E_r$ , volts	A( $10^{-9}$ Sec)	B( $10^{-9}$ Sec)	
150	-57.0	0.30	0.37	$\lambda = 18.4$ cm. $T = .61 (10^{-9}$ Sec) ← Max. output
200	-52.0	0.26	0.365	
220	-45.0	0.25	0.37	
250	-34.5	0.23	0.375	
300	-19.5	0.21	0.38	
350	-9.0	0.20	0.375	
400	-1.5	0.18	0.38	

This table gives the corresponding values of  $E_o$  and  $E_r$  for one of the numerous constant frequency curves we have plotted for tubes of widely differing structures. The value found for B from formula 23 is not very different from the value which would be obtained by identifying the present case with the case of the plane electrodes.

If for every value of A we adjust the bias of the reflecting electrode so as to reproduce the optimum frequency of the tube, it is found that the output given by the tube varies and goes through a maximum, as shown in Figure 5.

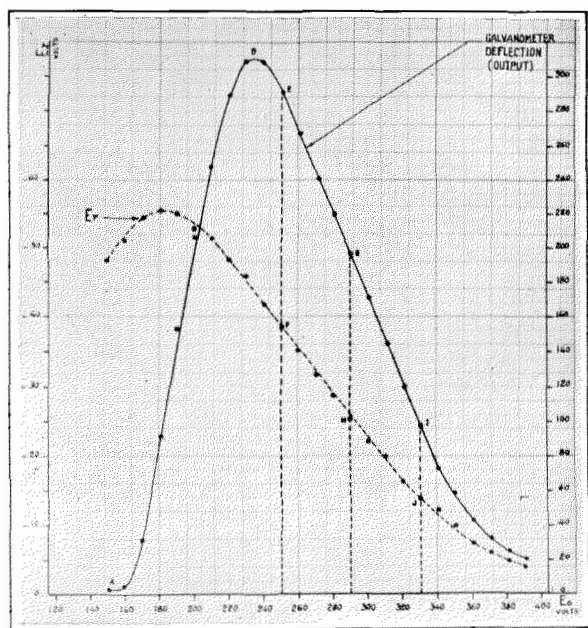

Figure 5—Variation of Output Along Constant Frequency Curve.

This maximum corresponds to the value of A which gives to  $g(\omega A)$  the optimum value, corresponding to the maximum negative value of  $g(\omega A) + g(\omega B)$ .

In all the experiments considered above, the filament current is kept at a constant value.

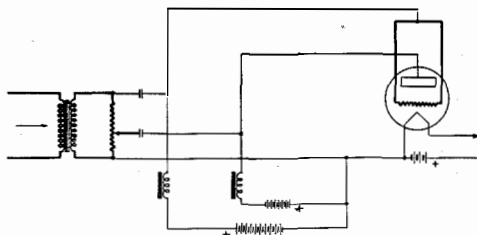

Figure 6—Amplitude Modulation of Micro-Ray Oscillator.

This is so chosen that the dissipation on the oscillating electrode never exceeds a reasonable value.

### 8. Application of Constant Frequency Curves to Amplitude Modulation

The constant frequency curves are very important for the correct utilization of the micro-ray tube. For instance, they give the possibility of obtaining amplitude modulation. In Figure 5, the right-hand side of the curve shows that the output there varies almost linearly in a certain region provided the relation between  $E_o$  and  $E_r$  follows the law indicated by Figure 4. Now this law gives also a linear relation between the two voltages. It is thus possible to apply the modulation voltage on both electrodes in such a way as to keep the correct relation between the voltages applied on the tube, and consequently the same frequency. It will thus be generally possible to obtain at least a 40% amplitude modulation (Figure 6).

### 9. Influence of External Circuit

The power which the electronic process inside the tube makes available is dissipated in the external circuit comprising, as already explained, a short transmission line leading to a radiating doublet.

Oscillations are sustained provided the apparent resistance as viewed from the tube does not exceed the negative resistance produced by the difference of phase between the leakage current

and the high frequency voltage along the oscillating electrode.

Supposing this condition to be fulfilled, the optimum frequency will be obtained when the oscillatory circuit is resonant on that frequency for which the electronic phenomena inside the tube are adjusted.

In order to express this last condition, we may consider that the tube is equivalent to a source of energy the internal reactance of which would be equal to the reactance of a short-circuited line having a wire length equal to the length of the wire of the oscillating electrode. The characteristic impedance of that line is not easy to determine, but we may assume for the sake of simplicity that it is not far different from the characteristic impedance of the transmission line which leads to the doublet. If this be the case, the condition for adjustment of the external circuit would simply be written:

$$\frac{\Lambda}{\lambda_1} + \frac{2l}{\lambda_2} = M \quad (24)$$

In equation 24  $M$  is equal to any integer. Assuming again that the wavelength along the transmission line is not very different from the wavelength along the wire of the oscillating electrode, we finally get:

$$\lambda = \frac{\Lambda + 2l}{M} \quad (25)$$

This should be considered as an approximation and gives a linear relation between the wavelength and the length of the transmission line. Figure 7 shows some of the results given by experiment.

It is to be expected that variation of the length of wire in the oscillating electrode will bring about a change of the range of wavelengths produced by the tube. The following table gives a certain number of experimental results obtained on tubes, for which the length of wire of the oscillating electrode was decreased, but the diameter kept constant. As shown in the table, the need to adjust the average time of transit of electrons between the filament and the oscillating electrode leads to an increase of D.C. voltage applied on the oscillating electrode and consequently to a bigger dissipation. A better alternative to get shorter wavelengths is to

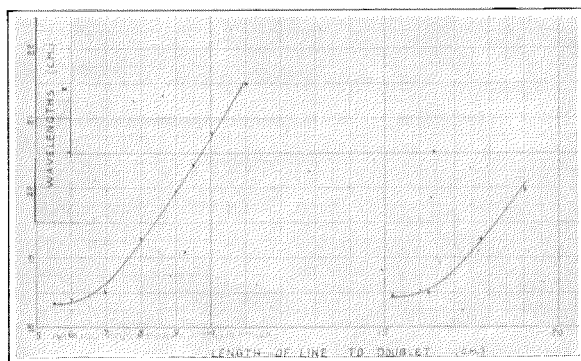

Figure 7—Experimental Variation of Wavelength with External Circuit.

reduce the diameter of the oscillating electrode as much as possible.

Tube No.	No. of Turns of Oscillating Electrode	$\Lambda$	Optimum Experimental Wavelength	Tube Adjustments		
				$E_o$	$I_o$	$-E_r$
1054	20	23.1	19.32	250	60	32
1055	20		19.90	220	60	29
1059	20		19.10	230	60	28
1072	18	20	18.00	270	60	49
1076	18		18.04	280	60	47
1084	16	18.5	16.82	310	70	39
1085	16		17.22	280	60	23
1086	16		16.90	300	60	35
1089	14	15.4	14.72	390	40	36
1092	14		14.72	380	50	29

## 10. Use of a Transmission Line Between Tube Circuit and Radiating System

The system considered above was used for the experiments between Dover and Calais on March 31st, 1931. The doublet was placed at the focus of a paraboloidal reflector; it has been found in certain cases that it would be more convenient to locate the transmitting or receiving tube behind this reflector in order to control or change the tubes more easily. This can be done by means of a transmission line which connects the oscillating circuit to the radiating system, which can take the shape of a half wavelength antenna.

As previous experiments have shown that replacing the doublet, which is of low resistance, by a half-wave antenna in the experimental system shown above in Figure 2 did not give quite as good results, it has been found necessary

to step down the resistance offered by the half-wave antenna, and this may be done with a quarter wavelength transmission line, the characteristic impedance of which is properly chosen. It is also essential to avoid all undue losses, especially radiation losses in the tube oscillating circuit.

Though secondary factors are certainly involved in the behaviour of the micro-ray tube on which we have experimented, the assumptions considered above give at least an explanation of the main experimental results and lead to a correct dimensioning of tube elements and circuits.

# The Childhood of Broadcasting in Norway

By E. A. BROFOS

*Vice-President, International Standard Electric Corporation*

EDITOR'S NOTE—Norway, on February 23rd, celebrated its tenth anniversary of radio broadcasting. Mr. Brofos' interest in the subject dates from its earliest days and because of his activities in Norway, "Radiobladet" asked him to write up his reminiscences. In view of its historic interest, *Electrical Communication* takes pleasure in publishing the following translation of Mr. Brofos' article which appeared in the February 17th issue of that journal. Permission to publish the article is gratefully acknowledged.

SINCE "Radiobladet" asked me to write a few words about my reminiscences from the first days of broadcasting in Norway, I am tempted to mention an early experience of this kind, even though the medium of radio was not involved.

I have in mind a small loud speaker equipment which I rigged up at the office of the newspaper *Nationen* in Oslo in the early part of 1919 for broadcasting the progress of the celebrated skating race, then taking place at Frogner, to the people gathered in Karl Johansgate.

It was a very simple installation, consisting of three small loudspeakers, which I had received from the Western Electric laboratories in New York. They were, however, connected to the skating rink by a telephone line and as this line proved to be too long and there were no suitable amplifiers available, I had to employ a human repeater, consisting of a person located in *Nationen's* office, with a telephone receiver connected to the observer at the skating rink. The former repeated word by word into a microphone connected to the loudspeakers the reports he received from Frogner and the messages were received with considerable interest by the crowd, which quickly gathered in Karl Johansgate. This early forerunner of broadcasting, however, had a short life, as the police considered that Karl Johansgate should continue to remain a public thoroughfare.

My activities in the radio broadcasting field date from the first months of 1922 when I began discussing this new technical development with the authorities in the four Northern countries. I had been considerably impressed with the reports I had received about the rapid intro-

duction of this service in America and, after having become acquainted with the very efficient broadcasting equipments which Western Electric Company, in New York, had placed on the market, active steps were taken to interest the authorities.

The early attempts to start this new service were not encouraging. I fear that, to begin with, a great deal of skepticism was exhibited in many quarters and radio broadcasting looked upon as rather a scientific toy which America could afford to play with. One question that occupied the mind in those days was how one could collect a revenue so as to make the service pay, considering that there would be no physical connection between the broadcasting station and the receiving sets.

To begin with, I believe the favoured scheme was to collect a special tax on all radio sets and loudspeakers sold but later this developed into the plan of a yearly license fee for the use of radio sets.

In view of the restrictions imposed on radio transmission in general, there were, of course, great obstacles in the way of having a commercial service started. In order to further the matter, we applied in the spring of 1922 for a concession to operate broadcasting stations in Norway, a special company to be formed for this purpose.

Other applications of a similar character followed, but the authorities were not disposed to make any decision.

However, as we all know, matters developed very rapidly and as early as the summer of 1922, the Norwegian Telegraph Administration became greatly interested in the new service.

But, since funds for a broadcasting station were not available and there was no decision as to how and by whom it should be operated, it was not possible to place an order for the equipment.

In the discussions with the Administrations, I recollect the keen interest taken in the matter by Overingenior Hermod Petersen who, with his pioneer experience in the radio telegraph field, soon realized that broadcasting had great possibilities.

As I also was firmly convinced of the great future of the new invention, I proposed during the autumn of 1922 to the Norwegian Telegraph Administration that my company, Norsk A/S Western Electric, now Standard Electric Aktieselskap, should lend the Administration a trial installation so that the system could be tried out in practice. As I remember it, the Western Electric Company had three sizes, namely, 50, 100 and 500 watt stations, the latter being considered a very powerful installation at the time. The Administration agreed to accept my proposal for a 500 watt station which, after some delay, arrived in Oslo at the end of 1922 and, during the following January and February, it was installed at Tryvandshoiden. This station, which afterwards was moved to the Administration's building in Oslo, rapidly proved to be a complete success and functioned splendidly. It was the first complete broadcasting station\* in the Northern countries and, in fact, the most modern European station outside of England where an exactly similar outfit installed in Birmingham was placed in service shortly before, namely, in November, 1922.

In those days the ether was not, as now, jammed by high power broadcasting stations and the result was that during the winter of 1923, the Christiania broadcasting station was a prominent one for the radio listeners in Europe and many were the favourable reports we received from foreign countries.

The year 1923 and the following winter was a very interesting period in broadcasting history

---

\*The equipment was sold in the fall of 1923 to the Swedish Telegraph Administration and is apparently still being employed in its Technical School in Stockholm. It has therefore been used to start broadcasting in two countries and has fulfilled its mission to the satisfaction of everybody.

in Scandinavia. The authorities and the public took an increasing interest in this new and far-reaching development, but how to operate and control it remained an unsolved problem for a long time.

During the spring of 1923, proposals were made to the Administration to issue a license for installation of radio sets at an annual fee of from Kr. 2.00 to Kr. 5.00, with no obligation on the part of the Government to broadcast a program. In this way it was felt that a control could be kept of the sets installed and funds obtained for purchasing a broadcasting station.

Aside from the entertainment value of broadcasting, we discussed from time to time various projects for the more useful application of broadcasting. Of outstanding interest was the proposal to use the system in northern part of Norway for the fishing fleet. In May, 1923, we arranged for a practical demonstration, by having a receiving set with a loudspeaker installed on a motor boat which went for a trip down Oslo Fjord. As far as I know, it was a pioneer experience of that kind and the motor boat, which was kindly placed at our disposal by Agent Hans Brun, had on board Expeditionschef Johannesen, Bureauchef Walnum, Direktor Per Larsen and others interested, as well as representatives of the press. The demonstration was a complete success and proved to the people present the value of this new medium for use with smaller vessels.

The great interest which the press has taken in broadcasting in Norway, undoubtedly has been of primary importance in promoting broadcasting in the country. Of the press representatives with whom I had occasion to discuss broadcasting in the early days, I am often reminded of Redaktionssekretar Rathe of *Morganbladet*, who, from the very beginning, took a great and very intelligent interest in the matter and placed before the public in a clear way the possibilities presented by the new invention.

In reviewing this early stage of broadcasting, I am greatly impressed not only by the tremendous development of broadcasting in the past 10 years, but also by the corresponding improvement in the equipment used. In 1923 the 500 watt station in Oslo was a plant of great



size; today it is replaced by one of 100,000 watts. In those early days, one was satisfied by understanding a portion of what was broadcast; today, the demand is not only that the complete message must be intelligible, but that the finer

nuances of speech and music must be transmitted over great distances without audible impairment.

It is only about 10 years since we started; what will the situation be in another 10 years?

# A Telegraph Distortion Measuring Set

By V. J. TERRY, B. Sc., and C. H. W. BROOKES-SMITH

*International Telephone and Telegraph Laboratories, Incorporated*

## Introduction

TELEGRAPH messages are transmitted by many types of apparatus and over many types of path. The latter may be provided, for example, by open wire lines or cable, by compositing on telephone lines, by voice frequency or carrier frequency telegraph channels; and again, each of these paths may be subdivided by the use of such apparatus as baudot distributors. To simplify the subsequent discussion we shall refer to any single path over which a telegraph message may be transmitted as a Telegraph Channel; this will include not only the line over which the telegraph transmission takes place but also apparatus such as filters, composite sets, detectors, etc., which are necessarily included *as part of the line*.

The performance of a Telegraph Channel until recently has been described in terms of the maximum speed in words per minute at which accurate operation has been obtained. Such information giving the limit of speed, while of practical interest, gives no reliable indication of what margin of safety is available at any given speed at which the channel is actually required to work. Recently, therefore, attempts have been made to determine this margin in a more scientific manner by measuring the more important imperfections introduced into a telegraphic message during transmission.

The ideal message free from imperfections will consist of a succession of signals separating spacing periods from marking periods and marking from spacing. Signal changes will occur suddenly and most, if not all, of the intervals which separate them will be exact multiples of a period called the time unit.<sup>1</sup>

The current which serves in practice to represent such a message has different properties. But although the changes from that steady value which is reached during a space to that which is reached during a mark and vice versa

are never absolutely sudden, the signals at least theoretically still have an instantaneous character because the moment at which the current passes through a particular value in one sense is taken to indicate the end of a space and the commencement of a mark, and the passage of the current through the same or a different value in the opposite sense is taken as the end of a mark and the beginning of a space. The signals thus defined are, however, not separated by exact multiples of the time unit, partly because of the imperfections of the man or machine involved, and partly because of the effects of stray induction and of electrical and mechanical inertia, etc., in the channels through which they pass.

In transmission through a channel, signals always will be delayed somewhat but if every signal were to suffer the same delay, any message received would be an exact replica of that transmitted. In such a case the channel would have added no material imperfection to the message and would be described as "distortionless," but if different signals are delayed to different extents, an ideal message is rendered imperfect to the extent of the difference between the greatest and the least delay. This difference expressed as a fraction of the time unit is the "distortion" as defined by the C. C. I. T.<sup>2</sup> Naturally, if the distortion be excessive, amounting to a time unit or thereabouts, the message will lose its distinctive meaning and become indecipherable, and distortion amounting to half this quantity will suffice to disable practically any telegraph receiver other than a human being. It is essential, therefore, that distortion be kept within tolerable limits and since, by periodical measurements, abnormal defects in telegraph channels can often be discovered before they are sufficient to cause actual errors of translation, the measurement of distortion is

---

<sup>2</sup> Etant donnée une liaison télégraphique, on appelle *degré de distorsion* de cette liaison le rapport de l'empiètement à la durée de l'intervalle élémentaire d'émission: ce rapport est égal au produit de la valeur de l'empiètement (exprimée en secondes) par la valeur de la vitesse de transmission (exprimée en bauds).

---

<sup>1</sup> The reciprocal of this time unit, expressed in seconds, is the speed of transmission in bauds.

a matter of great importance to all telegraph administrations or companies.

The measurement of distortion is a question of time measurement and the various instruments which have been developed to measure distortion have taken the form of clocks which show either stroboscopically or upon a permanent record the instance at which signals occur. Some which measure the interval between the transmission and reception of every signal are suitable only for the measurement of looped telegraph channels having their transmitting and receiving terminals close together, but those capable of indicating the signals on an absolute, if arbitrary, time scale may also be used to measure signals as they come from a transmitter or, in conjunction with a transmitter of accurate signals, to show the distortion introduced by an ordinary telegraph channel whose ends are remote one from another.

### *Telegraph Distortion Measuring Set*

The instrument described below has been devised to enable a direct measurement to be made of the amount by which signals will be distorted after passage through a channel under test. The set is for convenience made in three parts:

1. A Test Receiver on which percentage distortion is read directly.
2. A Test Transmitter which produces accurate telegraph signals.
3. An Oscillator which drives both the transmitter and the receiver.

It should be noted that any part of a channel, or indeed in some cases, telegraph apparatus dissociated from any channel, can also be tested by means of the set; the provision of accurate signals from the test transmitter enables receiving sections of a channel to be checked while transmitting sections can be checked directly on the test receiver.

### *Test Receiver*

The Test Receiver makes use of a "Standard" No. 4018-A low voltage cathode ray oscillograph tube. This is a recent development from the tube which has been fully described by J. B. Johnson (see Bibliography, references 4, and 5). It contains a heated filament cathode, a disc

anode having a small central hole through which the cathode rays emerge, four deflecting plates, the potentials of which control the position of the spot on the fluorescent screen where the cathode rays strike, and an additional electrode surrounding the cathode which serves to focus the electron stream. The method of using this tube in the Distortion Measuring Set differs from the usual arrangement in that no steady D.C. voltage from a high tension battery is applied between the anode and cathode, but instead a short impulse having a peak of several hundred volts is periodically applied from the secondary of a step-up transformer. The result is to produce on the fluorescent screen a bright spot of light at each impulse, the spot being located centrally on the screen if all the deflecting plates are at the same potential. If, however, a steady difference of potential is applied between one pair of plates, the spot on the screen becomes elongated into a bright line or flash owing to the varying voltage of the impulse producing electrons having different velocities, which naturally suffer different deflections in the electrostatic field between the plates. The inward and outward deflection, corresponding to the sudden rise and fall of the voltage impulse from the secondary of the transformer, occurs very suddenly, the time occupied being of the order of microseconds. Such flashes consequently form ideal timing marks to denote the occurrence of an event or, as in this particular application, the arrival of a signal.

In order, however, to produce a time scale, the four deflecting plates, instead of merely having between them a steady difference of potential, are supplied with two alternating potentials in quadrature. One pair of plates is connected across a condenser and the other pair across an adjustable resistance, the condenser and resistance being connected in series in the usual phase-split arrangement. If the value of the resistance is correctly adjusted, a circular rotating deflecting force will be obtained. A polar time scale is thereby obtained on the oscillograph screen in which one cycle of the alternating potential occupies one complete revolution. Under these conditions periodic impulse voltages between the anode and cathode produce radial flashes whose angular position

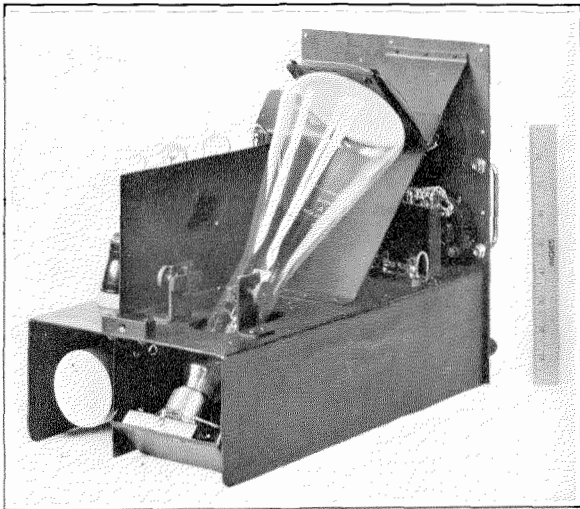

Figure 1—Test Receiver—Internal View.

depends on their timing relative to the rotating deflecting field. The production of these periodic impulses is controlled by the tongue and the marking and spacing contacts of a telegraph relay, which, for the purposes of distortion measurement, receives the output of the channel under test. On the arrival of each signal a bright flash is produced on the screen. By adjusting the frequency of the auxiliary oscillator to a value numerically the same as the speed of transmission in bauds, one revolution of the time scale represents one time unit, and the flashes occur at approximately the same place on the screen, early and late signals spreading them over an arc of the scale fixed to the screen. The extent of this arc on the scale is a direct measure of the percentage distortion since the scale is divided into one hundred divisions.

The circuit of the Test Receiver, a simplified diagram of which is shown in Figure 3, comprises the usual input connections to a telegraph receiving relay  $R_3$  from a line, the circuits associated with the step-up transformer  $T$ , and those associated with the cathode ray Tube  $G$ . It will be noticed that the potential for the focussing electrode, which is usually obtained from a dry battery, is in this case obtained from a potentiometer connected between anode and cathode, and consequently is not steady, but is also of the nature of an impulse. The focus obtained by this means is just as satisfactory as with a battery, the use of which is obviated.

The internal and external appearance of the instrument may be seen from Figures 1 and 2. The components are assembled on a steel chassis which forms an independent unit from the containing case, and various controls which are mounted on the front panel enable the operator to adjust the set. Keys are provided to enable the test conditions to be varied, i.e., the signals may be inverted, positive or negative signals omitted, and test signals from either double or single current systems measured. The oscillograph tube is held in an inclined position and is protected from stray fields by metal screens, while a pair of small permanent magnets which are held in adjustable mountings near the base of the tube serve to neutralise stray magnetic fields, and so initially keep the spot on the fluorescent screen central.

It will be seen that the Test Receiver forms a compact and portable unit. The chassis slides into the containing case and is secured in position by a single knurled screw. This screw also serves to close a door at the back of the containing case, thus giving access to the receiving relay for adjustment or replacement purposes without withdrawing the chassis from the case. The

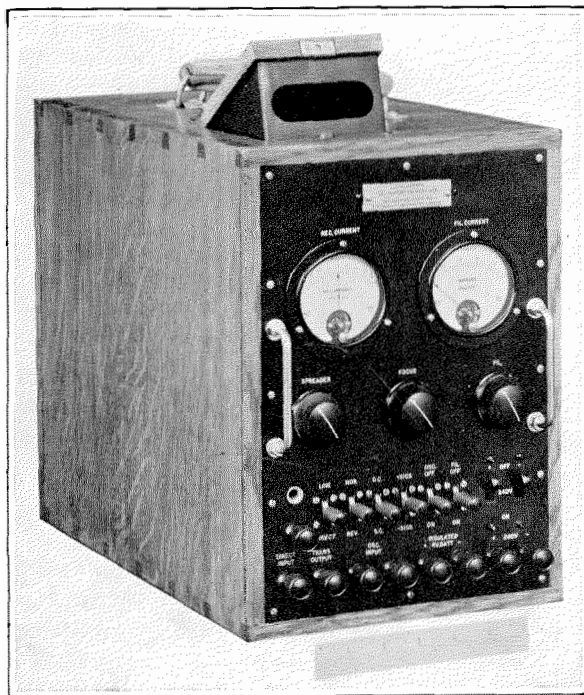

Figure 2—Test Receiver.

oscillograph screen may be observed through a small trap door in the top of the case, arranged with metal sides to form a viewing piece which excludes light sufficiently well to enable the flashes on the screen to be clearly seen, but at the same time admits enough light to enable the scale to be read.

### *Test Transmitter*

It is clear that measurements of this description, conducted on telegraph channels with a view to the location of faulty or maladjusted components, can only be carried out by a process of elimination or substitution, and it is therefore essential to have some reference standard giving perfect signals occurring exactly at the commencement of each time unit. A Test Transmitter has therefore been developed to provide such standard signals, and to give a variety of choice in the kind of signal train to be transmitted.

The circuit of the Test Transmitter, a diagram of which is shown in Figure 3, consists of two separate parts: the circuit incorporating a sequence switch and clean up relay, and the circuit associated with the motor driving the sequence switch.

It will be appreciated that the auxiliary oscillator producing the rotary deflecting field on the cathode ray oscillograph must be adjusted to be in step with the signals under observation. If this were not so the flashes would not appear stationary on the same part of the screen, and readings would be rendered impossible. In order, therefore, to obtain this synchronism in a simple manner the speed of the motor driving the sequence switch on the Test Transmitter is controlled by the common auxiliary oscillator. The motor M is of the attracted iron synchronous type which operates on direct current impulses obtained from a 24 volt battery through the contacts of a control relay R<sub>1</sub>. The number of poles on the motor and the reduction gear ratio are so arranged that the sequence switch runs in step with the oscillator, and synchronism so obtained between the transmitted signal and the rotating time base in the Test Receiver renders the flashes stationary.

This method of driving a synchronous motor through a control relay also has the advantage

that a common oscillator need not necessarily be used. In the description just given it was assumed that both terminals of the system under test were available at the same place, as in loop tests. The question of synchronism in that case does not arise as a common auxiliary oscillator can be used, as shown in Figure 3, both to provide the rotating time base and to control the speed of the Test Transmitter. In straight-away testing, however, it is not possible to use a common oscillator, and it may be undesirable or impossible to have any means of producing synchronism between the Test Transmitter and Receiver. The possibility of successful measurement rests, therefore, with the apparatus driving the sequence switch of the transmitter, and the apparatus producing the time base of the receiver, being sufficiently stable to be brought into and remaining in synchronism over a period of the order of one minute, or at least for a sufficiently long time to permit a single distortion measurement to be made. The use of vacuum tube oscillators at both ends of the system under measurement thus provides a ready solution to the difficulty, as their relative frequencies may be relied on to remain constant to within a few parts in a million during periods of the order of one minute.

The synchronous motor actually has four salient poles on its rotor and eight salient poles on the stator, alternate poles of which carry separate windings connected to the marking and spacing contacts of the driving relay. The vibrating tongue of the relay, therefore, sends direct current impulses alternately to each winding, a powerful rotating field being thereby obtained. An arrangement of this description will run satisfactorily when the relay winding is fed with alternating current at frequencies from 20 p: s up to 120 p: s or more, giving a wide range of motor speeds with a stability of the order of a few parts in a million for a few minutes at a time.

The hunting effect inherent in a synchronous motor is effectively damped out by a "mercury fly wheel." This consists of a hollow steel fly wheel filled with mercury and a number of radial partitions of steel wire gauze. The fluid friction between the mercury and the gauze on the occurrence of any angular acceleration effectively damps out any hunting of the motor.

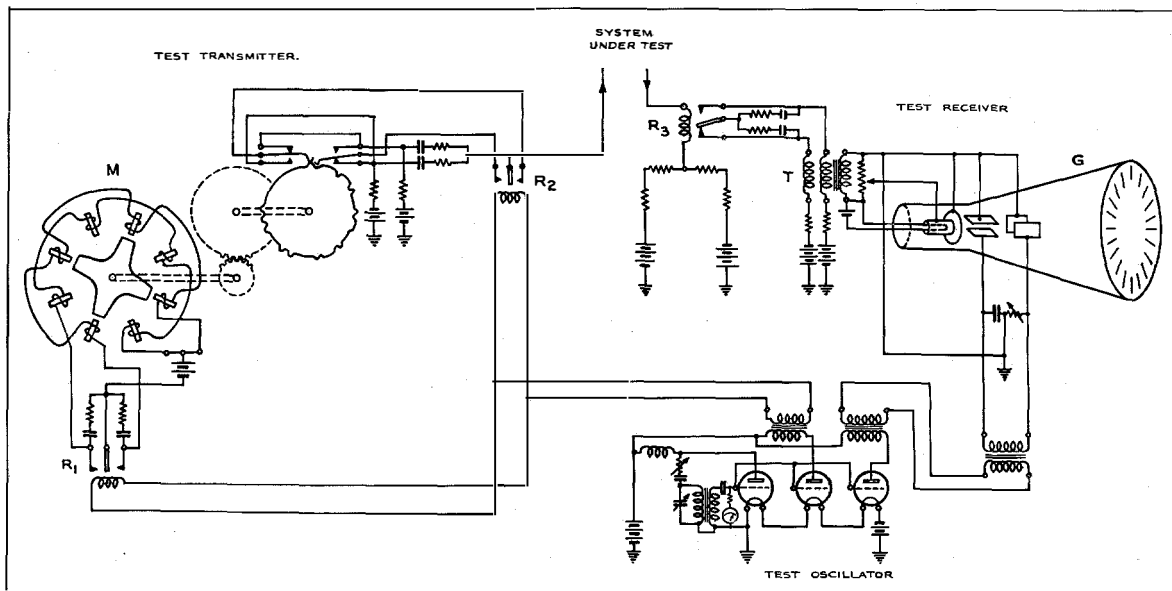

Figure 3—Simplified Circuit Diagram of Telegraph Distortion Measuring Set.

The sequence switch is the conventional arrangement of a disc cam made from insulating material, the periphery of which is machined to correspond with the test signal train to be transmitted. A hardened spring steel tongue resting on its periphery is moved in a radial direction by the form of the cam, and makes contact with springs above and below it. As mechanical imperfections in the form of the cam would inevitably introduce distortion, a telegraph relay  $R_2$ , also driven from the auxiliary oscillator, is interposed to clean up the distortion and so produce perfect signals. In order to make this arrangement work two sets of contacts and tongues, operated from a single cam, are provided for each kind of signal train, the tongues being relatively displaced by half a time unit. The phase relation between the movements of the two spring tongues and the armature of the "cleaning up" relay are adjusted so that the relay contacts actually make and break the signal current, the cam springs only serving the purpose of deciding what signal train shall be transmitted, by controlling the battery polarity applied to the marking and spacing contacts of the relay. The relay, therefore, entirely regulates the timing of the signals and, as it is driven from the auxiliary oscillator, transmits them with great precision free from distortion.

In order to make the distortion measurements of real value as a means of determining the transmission quality of a channel, it is necessary to transmit a representative train of signals containing those signal combinations found to be most liable to exhibit the maximum distortion, and eight cams providing eight alternative trains have been provided for the purpose. The worst combination for one type of telegraph channel is not necessarily the worst for another, but the test word "PARIS" in Morse code has been found sufficiently long and varied to meet ordinary requirements. This can, however, be replaced by a suitable word in teleprinter or any other code. For the purpose of locating trouble, simple periodic trains are, however, of more value, and consequently provision has been made for sending such signals, as for example, by means of three cams arranged to transmit combinations consisting of marking and spacing current impulses in the following ratios: 1:2, 2:2, and 5:1, the remaining cams being left to meet local conditions. In a previous type, the possible signal trains were limited to four, there being two separate cams displaced relatively by half a time unit for each train of signals. Any of these signals may be selected by operating one of four keys, a fifth enabling the marking and spacing to be interchanged. An additional key



enables the relay to be switched out of circuit and the output taken directly from any one of the sequence switch tongues. This facilitates checking the adjustment of the cams and contact springs by observing in the Test Receiver the relative phase and distortion in the signals produced from each cam. The test key is, however, made non-locking so as to prevent the possibility of test signals being inadvertently transmitted without the interposition of the cleaning up relay.

The initial phase adjustment between the relay and the sequence switch is carried out by sliding each spring pile-up tangentially until the correct relation, as observed in the Test Receiver, has been obtained. Once this adjustment has been carried out on all the springs there is no further need for phase adjustment when switching from one signal train to another. With large changes in the speed of transmission, however, small phase changes occur, and a mechanical adjustment is provided to enable the correction to be made. This has been obtained by making the motor casing an easy fit for the stator stampings, so as to allow rotation of the latter over an angle of  $50^\circ$  or  $60^\circ$ . A worm, held in bearings fixed to the motor frame, engages with teeth cut in the stator, and is driven from a small knob on the front panel through a pair of bevel wheels. By this means a fine phase adjustment is possible.

There is a wide permissible latitude of adjustment in the cam springs and phase relation before the distortion from these sources exceeds that which the relay can satisfactorily clean up. The perfect manufacture of the cams requiring exact quality in form and entire freedom from eccentricity is therefore not required. The sequence switch and cleaning up relay combination have an advantage over the more usual distributor method in which distortion is only kept at a low value by manufacturing and assembling with great precision, and at an inevitably high cost, whereas the use of the cleaning up relay enables test signals to be transmitted with a distortion not exceeding 0.5%, a figure which is very considerably better than is obtainable by any other means. Wear on the cams is negligible in its effect on the cleaned up signal, and in any case they may be expected to

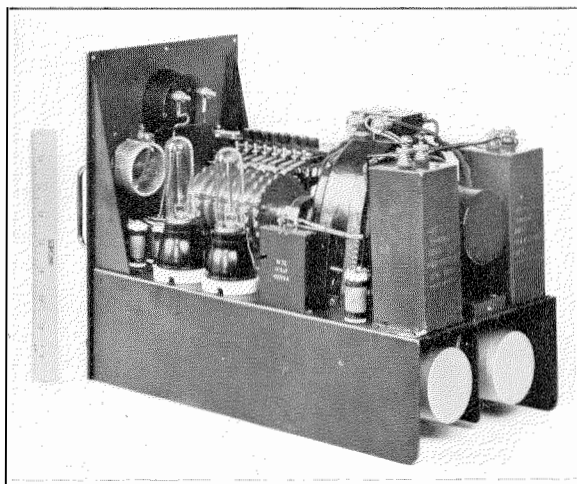

Figure 4—Test Transmitter—Internal View.

have a very long life before requiring attention. The sequence switch contacts also do not require attention as they never actually make or break the circuit. The cleaning up relay and the motor control relay only occasionally require adjustment, facilities for which are available in a telegraph station and form part of a regular routine.

The Test Transmitter, the internal and external appearance of which is shown in Figures 4 and 5, is built in the same general manner as the Test Receiver. A steel chassis forms an independent unit from the containing case, and carries all the components. The motor and sequence switch are mounted on the upper surface of the frame, and the necessary relays, resistances and condensers are secured under it. In order to insulate the relays from mechanical vibration generated by the motor, the relay mountings are secured to a framework which is sprung between steel springs fixed to the main frame. The mechanical movements of the armatures of the relays are consequently uninfluenced by vibration, even when the motor is running at a speed of 1800 r.p.m. corresponding to a transmission speed of 120 bauds. The front panel carries the necessary keys to select the type of signal train desired, and also a control switch and rheostat for the direct current supply to the motor. The latter drives the sequence switch through a double reduction 12:1 spur gear, and a starting handle, mounted on the end of the sequence switch shaft and projecting through to the front of the panel, provides a

ready means of running the motor up to synchronism manually. This is remarkably easily effected even at frequencies corresponding to speeds over 100 bauds. Variations in the current taken by the motor and indicated by beats on the ammeter connected in circuit and situated on the front panel materially assist in indicating when synchronism is being approached, but nevertheless the motor falls into step without any particular effort on the part of the operator.

### *Test Oscillator*

The auxiliary oscillators required at the transmitting and receiving terminals may be those normally provided in repeater stations. In order, however, to provide for cases where no such oscillator is available or where one cannot be situated in a convenient position adjacent to the other two units, a portable oscillator has been developed which forms the third unit of the complete telegraph distortion measuring set. This oscillator, as previously shown, fulfills the two functions of driving the relay controlling the synchronous motor of the Test Transmitter, and providing the polar time scale in the Test Receiver.

Experience shows that the wave form of the oscillator driving the relays in the transmitter

tends to be distorted from a sine wave and thus, if the Test Receiver is operated from the same oscillator, a perfectly uniform polar time scale is not produced. The difficulty has been avoided by constructing an oscillator with two independent outputs. The oscillator frequency is continuously adjustable over a range from 30 p:s up to 250 p:s, thereby covering the extreme range of transmission speeds likely to be met in practice.

The Test Oscillator, the external and internal views of which are shown in Figures 6 and 7, is constructed in the same general manner as the Test Transmitter and Receiver, the containing case being the same size. The various frequencies are obtained by means of a number of fixed condensers individually connected in parallel with the oscillatory circuit by means of small single pole switches. They have a total capacity of 4.1 mfd., the largest fixed value being 2 mfd. and the smallest being .0005 mfd. followed by a small variable condenser of .00075 mfd. which enables any exact frequency to be obtained. The amplitude of oscillation is controlled by an adjustable feed back resistance and is indicated by a microammeter in the grid circuit.

### *Operation*

From the foregoing description the general method of operation will be clear. The three units form a complete test set as shown in Figure 8 and for straightaway tests two complete sets are necessary, one at each end of the line. Test signals may then be transmitted from both terminals as required, and the distortion due to various signal combinations measured. Virtual synchronism is obtained if either of the two oscillators is adjusted so that the flashes in the adjacent Test Receiver cease to rotate, the adjustment simultaneously achieving the same result for both directions of transmission. The quality of transmission, either as an acceptance or routine maintenance test, can thus be quickly observed on a number of channels.

In loop tests on any system or channel, where both terminals are accessible for connection to the set, duplication of the test set is no longer necessary. Signals may then be passed through the channel under test and their initial perfection and resulting distortion measured on the test

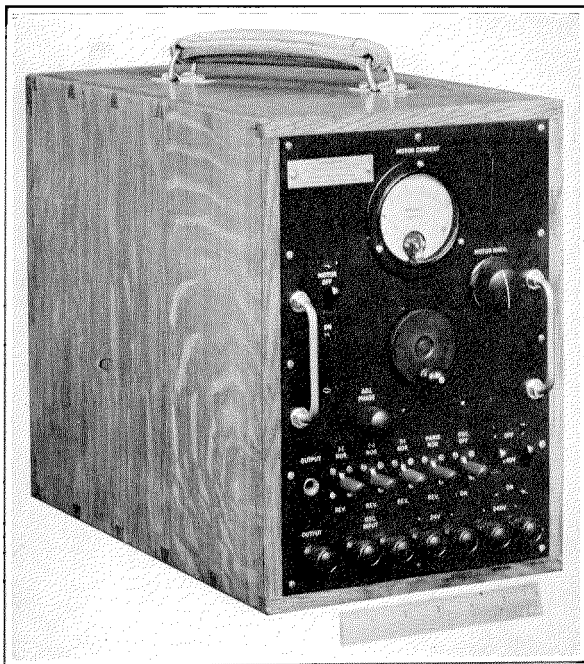

Figure 5—Test Transmitter.

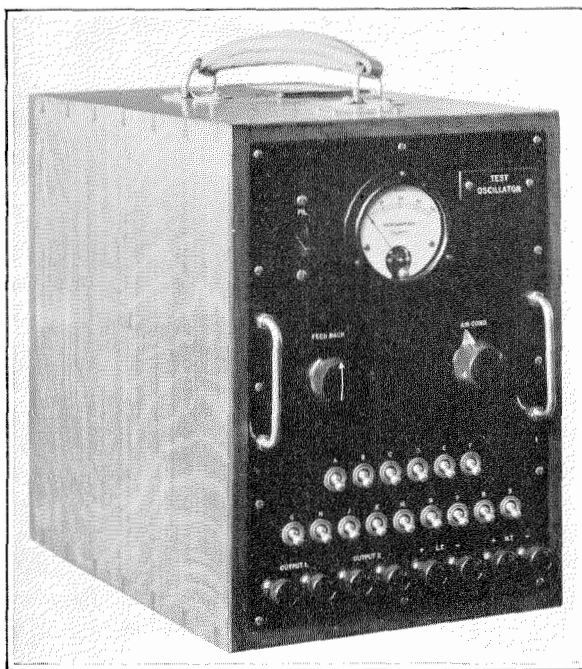

Figure 6—Test Oscillator.

receiver. The question of synchronism in this case does not arise as the transmitter and receiver are operated from the common auxiliary oscillator.

### Conclusions

The Telegraph Distortion Measuring Set which has been described represents a considerable advance in the development of such apparatus.

In the past, there have been no available methods of quickly observing the state of lines and apparatus, and it is only recently that efforts have been made to produce suitable equipment. Faults and trouble have been located by a hit and miss process, and unsatisfactorily operating equipment adjusted by attempting to find its optimum working condition by experiment. Too often equipment has been wrongly blamed, failures being due to totally different parts of the system.

This distortion measuring set, however, provides a remedy to this state of affairs. Not only does it provide a new and simple method of measuring distortion, but it also provides a standard distortion free signal of sufficient

length and complexity to be representative of actual working conditions. The set, moreover, is in a compact and portable form, requiring no special skill on the part of the operator. The maintenance is also small, and is chiefly covered in the routine practice of a telegraph station.

The method of measurement adopted as a number of advantages over existing methods in that vacuum tube oscillators are used as the stabilising elements with the result that virtual synchronism is obtained between the Test Transmitter and Receiver for a sufficient length of time to allow measurements to be made. The necessity for actual means of producing synchronism by the use of an additional channel is thus obviated, greatly simplifying straightaway testing. By the use of oscillators also the speed of the test transmission may be quickly varied over very wide limits without readjustment. Limiting operating speeds may consequently be found for particular parts of the equipment under test, and a measure of their state of adjustment and operating capabilities obtained. The method of measuring the distortion is also unique in that no rotating mechanism whatever is required to produce the time scale. Under certain conditions it can in fact be opened out by operating the auxiliary oscillator at two or three times its normal frequency, thus facilitating a more accurate measurement of small values of distortion if required.

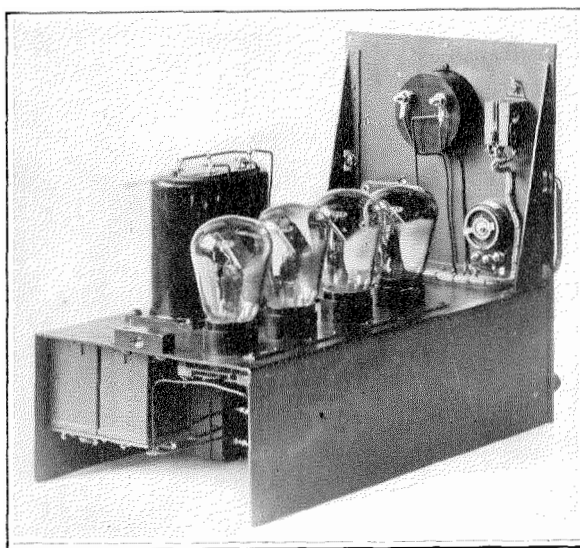

Figure 7—Test Oscillator—Internal View.



Figure 8—Complete Telegraph Distortion Measuring Set.

## Bibliography

1. A. Tipp and O. Romer, "Le Stroboscope pour les mesures de Distorsion en Télégraphie," *Documentation de la Troisième Réunion du C. C. I. T.*, Mai, 1931, Tome 1, pp. 30-35.
2. H. Nyquist, R. B. Shanck, and S. I. Cory, "Measurement of Telegraph Transmission," *Journal A. I. E. E.*, Vol. XLVI, pp. 231-240, March, 1927.
3. F. B. Bramhall, "Telegraph Transmission Testing Machine," *Trans. A. I. E. E.*, June, 1931, and *Electrical Engineering*, August, 1931.
4. J. B. Johnson, "Low Voltage Cathode Ray Oscillograph," *Bell System Technical Journal*, November, 1922.
5. J. B. Johnson, "The Cathode Ray Oscillograph," *Bell System Technical Journal*, January, 1932.

# Measurement of the Mutual Impedance of Circuits with Earth Return\*

By JOHN COLLARD, Ph.D.

*Associate Member of the Institution of Electrical Engineers*

**SUMMARY:** *The object of this paper is to place on record the results of tests carried out at three different sites in England at which measurements were made of the mutual impedance between two earthed circuits. Results are given for different separations from 5 to 800 metres and for frequencies from 200 to 3,000 cycles per sec. The results are shown to be in good agreement with the theory on this subject, and the resistivity of the earth was found to be 250 ohms/cm<sup>3</sup> at one site and 6,000 ohms/cm<sup>3</sup> at the others.*

## Introduction

**T**HE problem of the mutual impedance of circuits with earth return has received considerable attention in recent years in connection with the study of the inductive interference produced by high-tension power lines and electric traction systems in neighbouring communication circuits. The problem has been investigated theoretically by a number of authors and a fairly complete solution has been produced. A number of practical tests have also been carried out in different countries with a view to checking the theoretical formulæ, and while, in general, the tests have been in good agreement with the theory, the results obtained at certain sites have shown a divergence from the theory. It is thus very desirable, before the theory can safely be applied to the solution of practical problems, that test-results should be made available for as many different sites as possible. This paper has, therefore, been prepared with the object of placing on record the test-results which have been obtained in some mutual-impedance measurements carried out at three different sites in England. These three sites are:—

- (a) On the marshes at Reculver, near Herne Bay.
- (b) On the Yorkshire moors, near Goathland, about half-way between Pickering and Whitby.
- (c) On the shore near Weston-super-Mare.

At this last site, tests were made both at low tide, when the test wires were not covered by the

sea, and also at high tide, when the wires were covered to a depth of about 30 ft.

The geological features of these sites are very different, so that the test-results probably cover a wide range of earth resistivity. The more detailed particulars of the different sites and the results obtained are given in the following sections.

## Theory

It is not proposed to go into the theory of this subject in any detail since this has already been done by a number of different authors, to whose works reference is made in the Bibliography. Three authors, Pollaczek, Carson, and Haberland, appear to have arrived at a mathematical solution to this problem almost simultaneously and along very similar lines. From these three theories, a series of formulæ have been drawn up by the C.C.I.<sup>†</sup> giving the mutual impedance between two earthed circuits for a number of practical cases. These formulæ, together with curves plotted from them, are given in their "Directives" published in 1930.

For normal separations the formula for the mutual impedance between two parallel lines with earth return is of the form

$$M = \left\{ -\frac{4}{k^2 x^2} + 4 \frac{\text{kei}'(|kx|) - i\text{ker}'(|kx|)}{|kx|} \right\} \times 10^{-4}$$

\* Reprinted by permission from the *I.E.E. Journal*, Vol. 71, No. 430, October, 1932.

† Comité Consultatif International des Communications Téléphoniques à Grande Distance.

In this expression the symbols have the following meanings:—

$M$  = mutual impedance, in henrys per km,  
 $x$  = separation between the two lines, in cm,  
 $k = e^{\frac{2}{3}\pi i} \sqrt{4\pi\sigma\omega}$ ,  
 $\sigma$  = conductivity of the earth, in C.G.S. units per cm<sup>2</sup>,  
 $e$  = base of natural logarithms,  
 $i = \sqrt{-1}$

$\ker'$  and  $\ker i'$  are the differential coefficients of  $\ker$  and  $\ker i$ , which are the Kelvin forms of Bessel functions. Tables of these functions are given in British Association Report, 1915, pp. 36–38.

It will be noticed that this expression gives the mutual impedance in terms of the variable  $kx$ ,  $k$  itself being a function of the square root of the frequency and of the square root of the conductivity of the earth. The theory would, therefore, lead us to expect that, for any given value of earth conductivity, the mutual impedance should be a function of the variable  $x\sqrt{f}$ . In order to show with what accuracy the experimental results agree with the theoretical relations, the test values of mutual impedance have been plotted as a function of the variable  $x\sqrt{f}$  and in each case the theoretical curves for appropriate values of earth conductivity have been drawn in. Two sets of curves have been plotted, one set giving the magnitude of the mutual impedance expressed in henrys per kilometre, and the other set giving the corresponding angle of the mutual impedance.

### (a) *Reculver Tests*

These measurements were not actually carried out to test the validity of the theoretical formulæ and, since the purpose for which they were required did not necessitate any very great accuracy, a somewhat primitive form of testing apparatus was used. In spite of this the results show a reasonable agreement with the theory and are of interest since they correspond to the case in which the resistivity of the earth is very low.

*Description of Site.*—These tests were carried out in December, 1927, at a site on the marshes situated between the railway and the sea just east of Reculver, which itself lies about 4 miles to the east of Herne Bay. The ground, which is used for grazing purposes, has been drained by a number of intersecting dikes. The site was

not ideal for the purpose of testing the theory, since the latter assumes an earth of uniform structure. Actually, however, the results do not appear to show any divergence from the theory which could be attributed to the non-uniformity of the site.

A mile of 0.028-in. vulcanized-rubber-covered copper wire was laid out along the ground in a straight line to act as an inducing circuit. A second length of about  $\frac{1}{2}$  mile was used as the induced circuit and was placed parallel to, and near the centre of, the inducing wire and at separations of 30, 60, 150, 300, 600, 1,200, and 2,840 ft. from it. Each wire was earthed at each end by means of earth pins and, owing to the nature of the ground, a low-resistance earth connection was easy to obtain.

*Description of Apparatus.*—A variable-frequency valve oscillator was connected in one end of the inducing circuit through a transformer arranged to match the impedance of the line approximately with that of the oscillator. The current supplied to the line was measured by means of a thermocouple, and meter and measurements were made at frequencies of 370, 640, 810, 1,000, 1,500, 1,800, and 2,570 cycles per sec.

The measurement of the voltage in the induced conductor was made by connecting an amplifier to the conductor and then switching a telephone receiver alternately to the output of this amplifier and to a second valve oscillator which was set to the same frequency as that supplied to the inducing circuit. By means of an attenuator the output of this second oscillator could be varied until it was estimated that the tone heard in the receiver when connected to the amplifier in the induced conductor was the same as that heard when the receiver was connected through the attenuator to the oscillator. The apparatus had previously been calibrated in the laboratory so that the relation between the setting of the attenuator and the e.m.f. induced in the conductor was known. It was estimated that the balance could be carried out to within 0.5 decibel. This measurement, of course, only gave the magnitude of the voltage and, since this was all that was required in this instance, no attempt was made to measure the angle.

From a knowledge of the magnitude and fre-



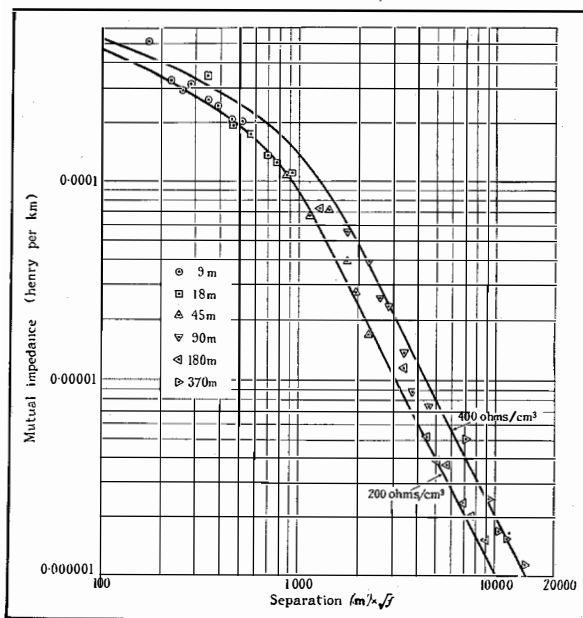

Figure 1—Reculver Tests.

quency of the inducing current, the magnitude of the induced e.m.f. and the length of the induced circuit, the mutual impedances for the different cases have been worked out and are plotted in Figure 1.

### (b) Goathland Tests

The results obtained at Reculver, in spite of their rather approximate nature, showed such a reasonable agreement with the theory that it was decided to carry out a second and more extensive series of tests to check this agreement still further. This time it was decided to measure both the magnitude and the angle of the mutual impedance and to use a method giving considerably greater accuracy than that used at Reculver.

*Description of Site.*—These tests were carried out in June, 1928, at a site on the Yorkshire moors about half-way along the Pickering-Whitby road. This site was chosen partly because it enabled a long, straight wire to be laid out and partly because it was so far away from any source of electric power that the effect of stray fields was avoided. A test hut was erected at the point where the road from Goathland joins the main road just north of Eller Beck. It was decided to use an inducing wire 5 miles in length and, as the main road runs for some

considerable distance substantially in a straight line, the inducing wire was placed for  $2\frac{1}{2}$  miles from the hut in each direction in a shallow ditch which lies on the west side of the road. The only point where it was necessary to divert the wire from the road in order to maintain the straight line was at Eller Beck. Here the wire was laid across the moor and was suspended across the Beck.

A 0.036-in. vulcanized-rubber-covered copper wire was used as the inducing circuit and was earthed at both ends by means of substantial earth-plates. At the centre the wire was cut and joined to a short twisted rubber-covered pair by means of which it was connected with the test hut. The induced wires were laid parallel to the inducing wire, starting at a point level with the test hut and running in a northerly direction. A 0.028-in. vulcanized-rubber-covered copper wire was used for this purpose and was placed at separations of 10, 20, 40, 80, 160, 320, and 575 meters from the inducing wire. For the close separations the induced wire had a length of about 380 m. and for the wider separations about 480 m. At the far end the wire was connected to earth pins and at the end near the hut a second earth connection was installed. A twisted pair was then run out from the test hut, one wire being connected to the end of the induced conductor and the other to the second earth connection. The twisted pairs to the inducing and induced wires were run out at right angles to the inducing wire.

The ground in the neighbourhood of the test site was very hard, making it difficult to secure good earth connections. According to geological surveys, it appears to consist mainly of sandstone to a depth of about 600 ft.

*Description of Apparatus.*—A diagram of the apparatus used for these tests is given in Figure 2. A variable-frequency valve oscillator was connected to a shielded transformer  $T_1$ ,  $M$  being a thermocouple and meter for measuring the current supplied by the oscillator. The output of  $T_1$  was connected in series with a second transformer  $T_2$  and a switch  $S_1$ . The switch  $S_1$  was used to connect the oscillator either to the inducing line  $AB$  or through an attenuator to the shielded transformer  $T_2$ . When the tone from the oscillator was switched to the inducing line,

an e.m.f. was induced in the induced conductor, XY, and was thence conveyed through the switch  $S_2$  to a shielded transformer  $T_3$  and then through another transformer  $T_4$  to an amplifier and receiver R. At the same time, tone from the oscillator was passed through transformer  $T_6$  to the coupling unit which is shown to the right of  $T_6$ . This coupling unit consists of a toroidal inductance L wound on a wooden core and having four windings. The two windings 1, 2 and 3, 4 are connected at one end through a transformer  $T_5$  to the amplifier and receiver and at the other end to a 0.8-ohm slide-wire and two 0.4-ohm resistors in series, with the centre point earthed. The other two windings, 5, 6, and 7, 8, of the inductance are connected to a resistor and condenser which are arranged to give these windings a resultant impedance of 600 ohms at all voice frequencies. At the other end, the windings are connected to a 600-ohm slide-wire and to two 300-ohm fixed resistors connected in series. When the moving contact of the 600-ohm slide-wire is in the mid position, no current flows through windings 5, 6 and 7, 8, so that no voltage is induced in the other windings. As soon as the moving contact is moved

from the centre position, a certain amount of current flows in the lower two windings of the inductance and thus produces in the other two windings an e.m.f. in quadrature with the oscillator current. The lower and upper pairs of windings are arranged to have a mutual inductance of  $300\mu\text{H}$ , and, since the lower windings are built out by the resistor and condenser to an impedance of 600 ohms, it follows that, when the moving contact of the 600-ohm slide-wire is moved to one end, the effective mutual inductance is  $+50\mu\text{H}$  and, when the moving contact is on the other end, the effective mutual inductance is  $-50\mu\text{H}$ . For settings of the 600-ohm slide-wire in between these points, the mutual is directly proportional to the distance of the slide-wire from the centre. The contact which is normally connected to the centre point of the two 300-ohm resistors may be moved, as shown in the diagram, so as to connect to either end of these resistors and thus adds  $\pm 50\mu\text{H}$  to the mutual inductance. The upper slide-wire is provided to produce an e.m.f. in phase with the current. The whole coupling device, which is the invention of Mr. A. D. Blumlein,\* thus pro-

\* British Patent No. 338588.

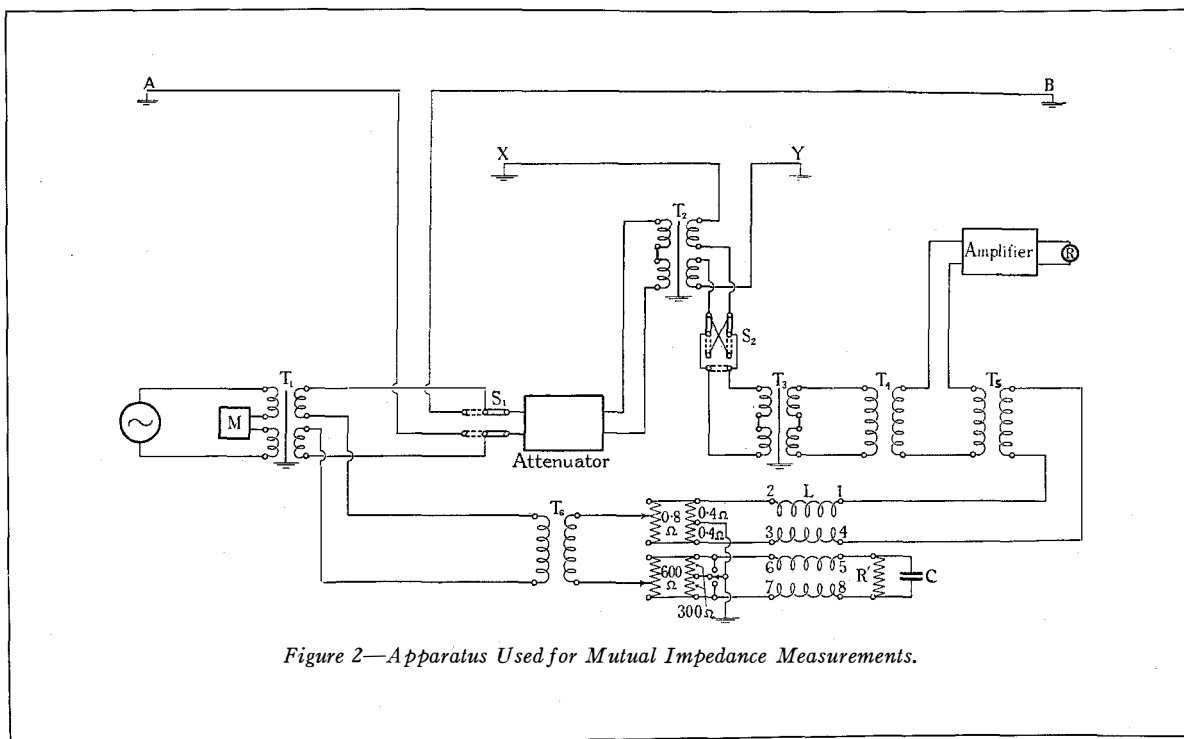

Figure 2—Apparatus Used for Mutual Impedance Measurements.

vides a very simple and convenient means of obtaining a variable impedance of known value. The device has another very important property and that is that, since the inductance is toroidal, it is unaffected by stray magnetic fields.

It is not practicable to arrange this device to cover the very wide range of impedances required in the tests, so that the two transformers  $T_4$  and  $T_5$  are arranged to have their ratios variable in a number of steps. In making the measurement the ratios of  $T_4$  and  $T_5$  and the settings of the two slide-wires of the coupling unit are so adjusted that the tone heard in the receiver is a minimum.

The transformers,  $T_1$ ,  $T_2$ ,  $T_3$ , and  $T_6$ , are necessary to separate the different parts of the apparatus and so prevent cross-talk from one part of the circuit to another. Their introduction, however, and the capacitance of the twisted pair running out from the test hut to the induced circuit both cause slight changes in the magnitude and phase of the testing currents. It was originally intended to overcome this difficulty by calibrating the apparatus in the laboratory. When the tests on the site actually came to be made, however, it was found that the short showers which occurred covered the twisted pair with moisture, while the effect of the wind in between the showers was to tend to dry the wire. The effect of this constant change in the amount of moisture on the twisted pair was to cause the capacitance of the pair to vary in a very marked and erratic manner.

It was therefore decided to carry out a calibration measurement on the site immediately after each test measurement. For this purpose a small known voltage was introduced into the induced conductor by means of an attenuator and a transformer  $T_2$ . The transformer was placed near the induced conductor and was connected back to the hut by a second twisted pair. Since the attenuator was arranged to have an impedance of only a few ohms on the output side, the effect of the variations in capacitance of this second pair was inappreciable. The effect of  $T_2$  on the calibrating voltage was allowed for by previous calibration.

Measurements were made at frequencies of 200, 300, 500, 800, 1,000, 1,500, 2,000, 2,500, and 3,000 cycles per sec. The magnitude of the

mutual impedance is plotted in Figure 3 and the angle in Figure 4.

### (c) Weston-super-Mare Tests

These tests were carried out in order to obtain further information on the agreement between the theoretical formulæ and practical results. The site at Weston was chosen because it enabled two sets of results to be obtained, the first when the sea was out and the second when the test wires were covered by sea water. The first set of results corresponds to the case of two circuits on the land which had already been tested at Reculver and Goathland. The second set of results corresponds to the case which occurs when two submarine cables run into the same landing place. Inductive interference often occurs in such a case and it was, therefore, considered of interest to determine whether the theory could also be applied to this case.

*Description of Site.*—These tests were carried out in October, 1929, at a point on the shore between Sand Point and St. Thomas's Head about 3 miles to the north of Weston-super-Mare. This site was chosen principally because of the extremely high tide, about 40 ft., occurring there. It was also sufficiently far away from sources of electrical power to avoid stray fields. A stone hut on top of the cliff was used to house the testing equipment, and rubber-covered twisted pairs were run down to the beach to connect with the inducing and induced wires.

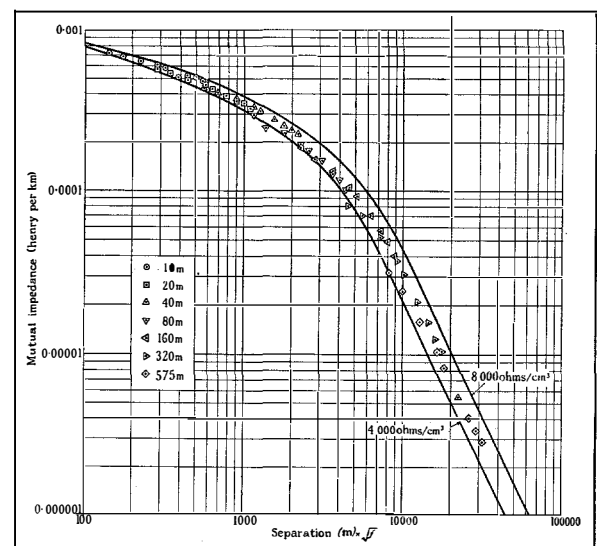

Figure 3—Goathland Tests.

The inducing conductor consisted of about  $\frac{1}{2}$  mile of 3/.029 tough rubber-sheathed copper wire laid out along the shore and earthed at each end. The induced wires were of the same material and were placed parallel to the induced wire near its centre; their length varied from 100 to 200 yards and they were earthed at each end. A twisted pair from the test hut was connected into the middle of the inducing wire and another twisted pair into the middle of the induced conductor. These two pairs were kept about 20 yards apart to avoid pick-up from one to the other. Owing to the fact that the wires would all be under water for a large part of the tests, special care was taken in insulating all joints so that water should not penetrate. The wires were kept in place by weighting them down with heavy stones at a number of places, and no trouble was experienced due to shifting of the wires by the sea. The induced wire was placed at the following separations from the inducing wire, 5, 10, 20, 40, 80, and 120 meters.

The wires were laid at low tide and, after the tide had risen, were covered to an average depth of about 30 ft.

*Description of Apparatus.*—The apparatus used for these tests was almost identical with that used at Goathland, so that a detailed description need not be given. The calibrating arrangement was not used this time since, owing to the shorter length of the twisted pairs and the lower impedance of the inducing and induced wires, the effect of the capacitance of the pairs was extremely small. The apparatus was therefore calibrated in the laboratory before being taken to the site, and a slight calculated correction was made for the capacitance of the pairs.

Measurements of mutual impedance were made at the following frequencies, 200, 300, 500, 800, 1,000, 1,500, 2,000, 2,500, and 3,000 cycles per sec. Two sets of tests were made, one with the tide right out and the other with the tide right in. The magnitude of the low-tide mutual impedances are plotted in Figure 5 and the angles in Figure 6. The magnitudes for the high-tide case are plotted in Figure 7.

### Discussion of Results

In judging the accuracy with which the experimental results agree with the theoretical curves,

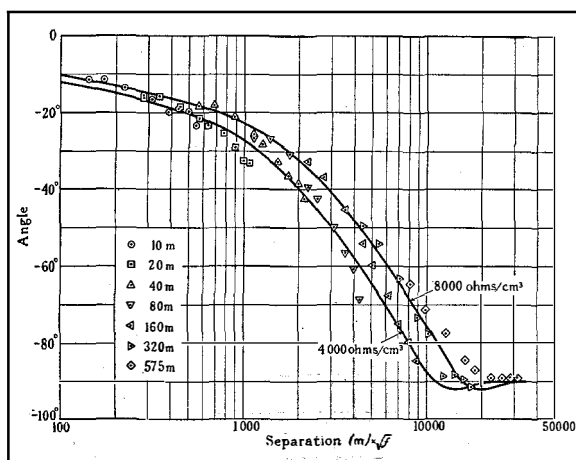

Figure 4—Goathland Tests.

most attention should be directed towards the tests at Goathland and the tests at low tide at Weston-super-Mare, since these are the tests which were carried out with the greatest accuracy. These two sets of results have been plotted in Figures 3, 4, 5, and 6, and in each case two theoretical curves have been drawn in, one for an earth resistance of 4,000 ohms/cm<sup>3</sup> and the other for a resistance of 8,000 ohms/cm<sup>3</sup>.

Taking, first of all, the two sets of results for the magnitude of the mutual impedance, Figures 3 and 5, it will be noticed that, except for a few isolated points, the experimental results all fall within the two theoretical curves, and a mean curve drawn through the points would follow very closely the shape of the theoretical curves. In the case of the angle of the mutual impedance, Figures 4 and 6, the experimental points appear to deviate considerably more from the theoretical curves, although the general trend of the points follows the line of the theoretical curves. Fortunately, from the practical point of view, we are more concerned with calculating the magnitude of the mutual impedance than its angle, so that deviations of the measured angles from the theoretical curves are of relatively small importance. In any case, the distribution of the points appears to be quite erratic, which would indicate that the deviations are due more to experimental errors than to any systematic departure from the theory. The results obtained at Reculver, plotted in Figure 1, will be seen to agree reasonably well with the theoretical curves when the relatively smaller accuracy of these tests is taken into account.

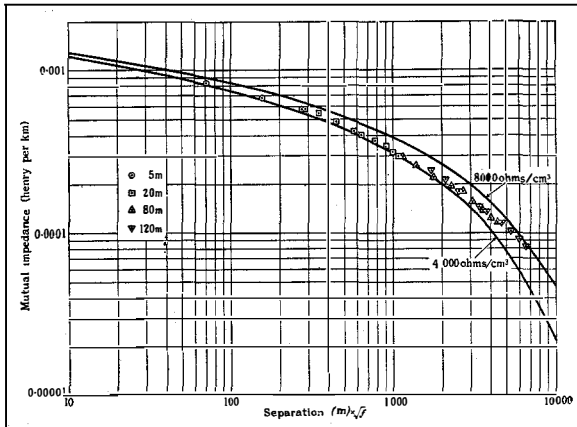

Figure 5—Weston-super-Mare Tests (Low Tide).

The tests taken at high tide at Weston-super-Mare show considerably greater deviation from the theoretical curves, and there are a number of reasons which would account for this. In the first place, the theory, which was developed for the case in which air and earth were the media, does not strictly apply to the case of wires in the sea. It was thought, however, that if the depth of water covering the wires were large compared with the separation between the two wires, then, since the resistivity of the sea is so much less than that of the earth (30 ohms/cm<sup>3</sup> compared with 6,000 ohms/cm<sup>3</sup>), the case might be considered as equivalent to an inverted air-earth case, that is to say, with the water taking the place of the earth in the normal case and the earth taking the place of the air in the normal case. If this were so, then the same theoretical formulæ should apply. In order to see whether this assumption does hold or not, the experimental points have been plotted in Figure 7, and three theoretical curves have been drawn in, corresponding respectively to resistivities of 20, 40, and 80 ohms/cm<sup>3</sup>. It will be seen that for the points taken at the closer separations the agreement with a theoretical curve for a resistivity of about 30 or 40 ohms/cm<sup>3</sup> is quite good, and actually the resistivity of the sea should be somewhere about this value. For the larger separations, the points deviate rather more from the theoretical curves and this is only to be expected since the depth of water, about 30 ft., is no longer large compared with the separations. Indeed, it is a little surprising that with this

small depth of water even the separations of 5 and 10 m. are in good agreement with the theory. There seems to be no doubt that, provided the depth of sea water is more than twice the separation between the two wires, the theoretical expressions would approximate quite well to the experimental results.

Tests of mutual impedance carried out in Germany have shown that in order to make the theory agree with the experimental results it was necessary to take a different value of earth resistivity for each frequency. As a result of this, the C.C.I. when making use of the theory for practical purposes have proposed to use a value of resistivity proportional to the square root of the frequency. It is, therefore, of interest to examine the test-results given here to see whether there is any sign of the resistivity varying with frequency. Take first of all the Goathland results, Figure 3. The maximum variation of frequency employed here was 200 to 3,000 cycles per sec., so that, if the resistivity should vary as the square root of the frequency, we should expect a variation of resistivity of about 4 to 1. If the points for each separation are examined, it will be seen that there is a slight tendency for them to depart from the theoretical curve, the points at the lower frequencies appearing to move over towards the theoretical curve for the lower resistivity. The total change of resistance necessary to account for this effect is, however, nothing like the 4 to 1 just mentioned and is actually only about 1.5 to 1. The Reculver tests, Figure 1, for which the maximum frequency range was 370 to 2,570 cycles per sec.,

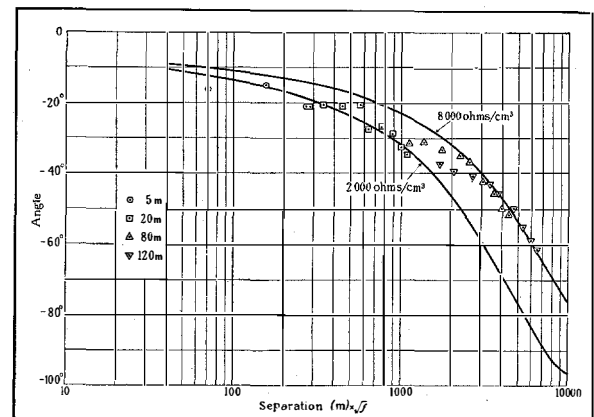

Figure 6—Weston-super-Mare Tests (Low Tide).

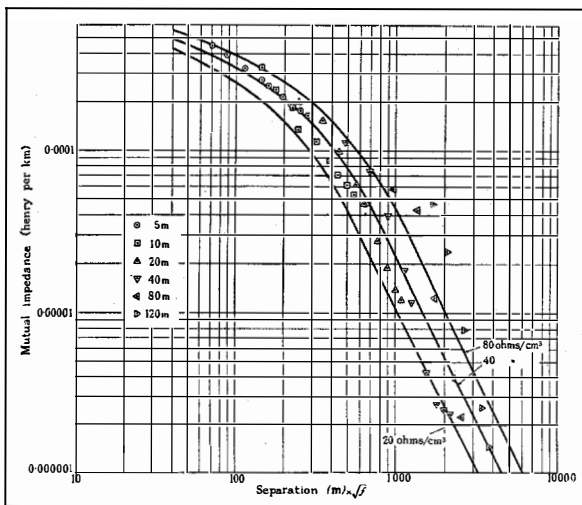

Figure 7—Weston-super-Mare Tests (High Tide).

do not appear to show any sign of this change in resistance with frequency. In the case of the low-tide measurements at Weston-super-Mare with a frequency of 200 to 3,000 cycles per sec., there again seems to be a very slight tendency for a change of resistance with frequency, though it is even smaller than at Goathland and seems to be reversed in the case of the 20-meter points.

Curiously enough, the measurements of angle at Goathland, Figure 4, seem to require a change of resistance with frequency in the opposite direction, that is to say, a lower resistance for the higher frequencies. In any case, the mutual impedance depends only on the square root of the resistivity. It seems reasonable to conclude, therefore, that for these three sites and for the range of frequencies employed in these tests, a change of resistance with frequency to make the theory fit the experimental results is either not required at all or is so small as to be of negligible importance in practical cases.

Another point of some interest which arises from these tests is the short lines to which the theory, which assumes an infinite conductor, seems to apply. At Weston-super-Mare, for example, the inducing line was only  $\frac{1}{2}$  mile and the induced line in some tests only 100 yards.

The test-results show that the following values of the resistivity of the earth give the best agreement with the theory in the different cases:—

Reculver	.. .. .	250 ohms/cm <sup>3</sup>
Goathland	.. .. .	6,000 ohms/cm <sup>3</sup>
Weston-super-Mare (low tide)	.. .. .	6,000 ohms/cm <sup>3</sup>
(high tide)	.. .. .	40 ohms/cm <sup>3</sup>

### Conclusions

The most important conclusion to be obtained from these tests is that the Carson-Pollaczek theory agrees very well with the experimental results in the three sets of tests described here. Furthermore, the variation of the earth conductivity with frequency, if it occurs at all, is extremely small and can therefore be neglected for all practical purposes. The resistivity of the earth has been found to vary from a value of about 250 ohms/cm<sup>3</sup> at Reculver to a value of about 6,000 ohms/cm<sup>3</sup> at Goathland and Weston-super-Mare. This indicates that it is desirable, when applying the theory to some particular site, to know the conductivity of the earth at that site rather than to assume a uniform conductivity for all sites.

The tests carried out at high tide at Weston-super-Mare indicate that, provided the separation between two wires laid in the sea is smaller than the depth of water over the wires, the Carson-Pollaczek theory applies equally well in this case, the sea being considered as the earth and the earth as the air in the normal case. This point is of use in considering problems of interference between adjacent cables in the sea.

Finally, the test-results described here show the desirability of carrying out still further tests in order to obtain a more detailed knowledge of how the conductivity of the earth varies according to the geological nature of the earth and under what conditions it is necessary, as in the German tests, to assume a variation of conductivity with frequency. In this connection it is of interest to note that the Electrical Research Association, in conjunction with the Commission Mixte Internationale, are carrying out similar tests in England at several sites.

In conclusion the author wishes to thank the International Telephone and Telegraph Laboratories, Incorporated, for permission to publish this paper. He would also like to take this opportunity of expressing his indebtedness to those members of the Interference Department of the Laboratories who have assisted in the tests described here, and in particular to Mr.



A. D. Blumlein, B.Sc.(Eng.), for his work in developing the testing apparatus used in the Goathland tests.

### **Bibliography**

1. F. Breisig, "The Calculation of the Magnetic Induction from Alternating-Current Lines with Earth Return," *Telegraphen-und Fernsprechtechnik*, 1925, vol. 14, p. 93.

2. O. Mayer, "The Earth as an Alternating-Current Conductor," *Elektrotechnische Zeitschrift*, 1925, vol. 46, pp. 1352 and 1436.

3. R. Rüdberg, "The Distribution of Earth Currents in the Neighbourhood of Alternating-Current Lines," *Zeitschrift für Angewandte Mathematik und Mechanik*, 1925, vol. 5, p. 361.

4. F. Pollaczek, "The Field of a Single-phase Alternating-Current Line," *Elektrische Nachrichten-Technik*, 1926, vol. 3, p. 339.

5. J. R. Carson, "Wave Propagation in Overhead Wires with Ground Return," *Bell System Technical Journal*, 1926, vol. 5, p. 539.

6. G. Haberland, "Theory of the Conduction of Alternating Current through the Earth," *Zeitschrift für Angewandte Mathematik und Mechanik*, 1926, vol. 6, p. 366.

7. Collet, "The Magnetic Field in the Neighbourhood of an Alternating-Current Line," *Bulletin de la Société Française des Electriciens*, 1927, vol. 7, p. 604.

8. H. E. Bowen and C. L. Gilkeson, "Mutual Impedance of Ground Return Circuits," *Transactions of the American I.E.E.*, 1930, vol. 49, p. 1370.

9. "Guiding Principles (Directives) of the C.C.I." (1930 Edition).

# Proceedings of the International Consultative Committee on Long Distance Telephony, Paris, September 14-21, 1931

## ENGLISH TRANSLATION

**T**HE last full Meeting of the Comité Consultatif International was held in Paris, September 14-21, 1931, the proceedings of which have just been published in the form of an English translation, by the International Standard Electric Corporation.

This volume of 350 large quarto pages contains all the recommendations of the C.C.I. in practically all fields of long distance telephone practices. Under the general heading of Transmission, definitions of principles and rules pertaining to standards are given as applicable to wire, carrier and radio-broadcast circuits. Similar rules and regulations for telephone apparatus, overhead and underground lines and maintenance thereof also are given.

A valuable feature of this publication is a series of no less than 26 typical specifications for cables, apparatus and systems in a modern telephone plant. One section is devoted to an exhaustive bibliography of English, French and German publications in the communication art. The extent of this bibliography is indicated by the fact that no fewer than 728 references are given to such publications.

In another section the various recommendations of the C.C.I. on questions of traffic, operation and tariffs are given. These include recommendations on the various classes of calls and types of facilities, methods of operation and rates for radio circuits, radio-broadcast circuits and picture transmission circuits.

Another important feature is the section on the protection of telephone lines against high tension disturbances and electrolytic corrosion with a description of modern methods to combat these troubles. In this connection, three articles by eminent telephone technicians are included in the publication for reference purposes.

A complete list of delegates, together with verbatim reports of the opening and closing sessions of the plenary meeting complete the subject matter.

As a useful guide to the reader, the Table of Contents and the Alphabetical Index give in parallel columns the page numbers of the original as well as of the translated edition.

Unofficial English translations of the C.C.I. Proceedings by the International Standard Electric Corporation have appeared regularly since the first issue of the Proceedings,\* and have been distributed free to an ever-increasing circle of telephone engineers throughout the world. The edition is limited in number and the demand has become so great, however, that it has become necessary to make a nominal charge for the present volume. Requests for copies should be addressed to the Information Department, Standard Telephones and Cables, Ltd., Connaught House, Aldwych, London, W.C.2, England.

---

\* "Proceedings of the International Consultative Committee on Long Distance Telephony," *Electrical Communication*, October, 1932.

# A Controlled Single Motion Switch System Operating in the London Area

## The Bypass System at Advance Exchange

By J. H. E. BAKER, B.S., A.C.G.I., A.M.I.E.E. and E. P. G. WRIGHT, A.M.I.E.E.  
*Standard Telephones and Cables Limited*

### Introduction

**T**HE new Advance Exchange which was opened on February 23rd, 1933, by Major C. R. Attlee, a former Postmaster General, represented the 51st Automatic Exchange to be opened in the London Area. Each of the first 50 exchanges is of the Step-by-Step Director type.

The circumstances attending the introduction of the Bypass System are unique because in the past the completion of an equipment with entirely new principles has been concurrent with the commencement of conversion of an area from manual to automatic. In the present instance, since the conditions had already been formulated, the character of the switching and operating methods were moulded to take full advantage of the natural resources of the original system. Consequently, such changes as have been incorporated in the new system are of particular interest.

Before it was decided to give a trial to a system so radically different in principle, the possibilities of the Bypass System were examined in very great detail by the Fundamental Planning Section of the British Post Office, with which a committee was established to ensure that full provision was made for all existing and contemplated requirements of the area. This committee also examined the desirability of introducing the new facilities which were claimed for the Bypass System.

### The Engineering of Advance Exchange

Some idea of the magnitude of the engineering problem can be envisaged when it is appreciated that not only every automatic circuit but also practically every manual board and desk circuit was new and untried. In addition, the apparatus as represented by the switch and the relay was also without extended experience, although

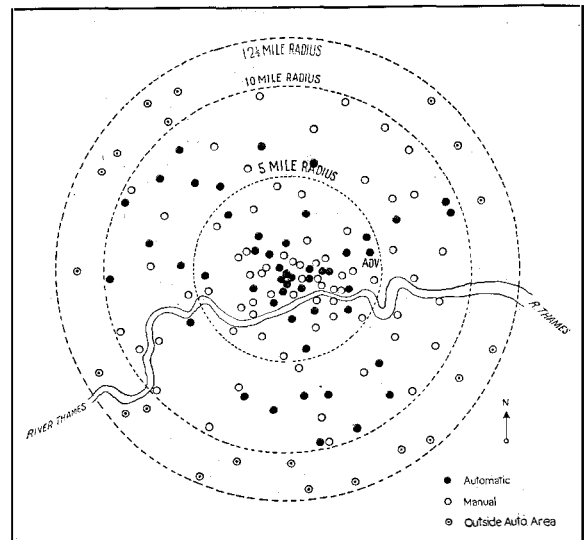

*Diagram of Exchanges in the London Area.*

in this case, considerable knowledge was available of the behaviour of similar designs. To avoid expense and delay, it was decided that the facilities to be provided should be specified by the Operating, Maintenance and other Sections concerned in the General Post Office and that the circuits should be designed and manufactured by the Standard Telephones and Cables, Limited, without individual approval or test by the customer and that, finally, the completed installation should be subjected to a rigorous inspection and test as a guarantee of the reliable and satisfactory condition of the equipment before placing it in service. It will be appreciated, therefore, that in addition to the fundamental design effort, it was necessary to make elaborate traffic studies and complete equipment designs and layouts. Considerable thought was expended in the preparation of testing methods and routines both in the factory and the field and infinite patience was required for the compilation of key sheets, wiring schematics and circuit explanatories.

### The London Area

The total number of exchanges in the area of a 10-mile radius including tandem, toll and trunk exchanges, is approximately 120 and the ultimate number may reach 400 if and when the radius of the area is extended to  $12\frac{1}{2}$ , 15 miles or even beyond.

Each exchange is represented by a three-letter code and each subscriber's number comprises four digits. The various special services are identified by three-letter codes with the exception of assistance which is obtained by calling the single digit 0. The subscribers are divided into two groups, one of which is permitted to complete automatically only single fee connections.

In the existing Step-by-Step System, all calls originated by subscribers connected to automatic exchanges are registered and established by directors which are divided into groups corresponding to the first digit dialled and selected by "A" digit selectors.

Local calls are established through 1st code, 1st and 2nd numerical selectors and final selectors. Transmission bridges are introduced at the 1st code and final selectors. In addition to

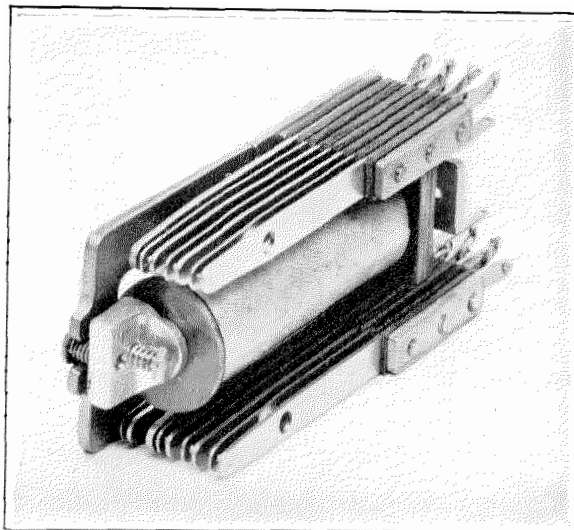

*Type of Universal Relay Employed Throughout Advance Exchange.*

the P.B.X. final selectors for groups up to 10 lines, separate circuits are provided as required for groups between 10 and 20 lines and for groups over 20 lines. All the group selectors give access to 20 outlets in each level.

The code translating facility in the director permits routing through the central tandem or one of the four sub-tandems of traffic to distant exchanges to which there are no direct circuits.

Outgoing traffic to a manual exchange is passed from the director to a coder which signals the terminating exchange and, when the latter is ready, transmits the required number by code pulses for display before an operator.

Incoming traffic from a manual exchange is keyed up by the operator, causing a combination of four voice frequencies to be impressed on the line. These signals are received on voice frequency relays and retransmitted as normal dial impulses to the selectors.

Incoming short distance toll traffic is handled in substantially the same manner through a centralised toll exchange. Outgoing short distance traffic terminates on a local manual position from which the connection is established through a manual transit exchange, the local operator controlling the call and recording the length of the conversation.

The outgoing long distance traffic is directed to a centralised recording board whence it is

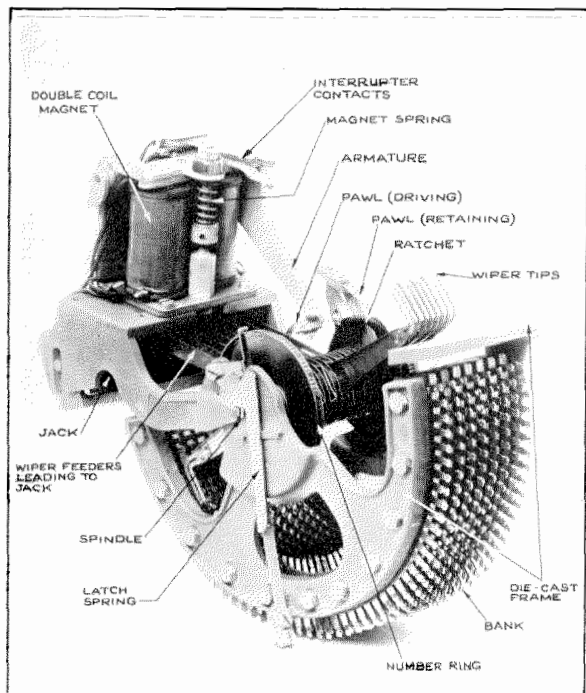

*The Uniselector.*

extended to be set up on a demand basis where possible. The corresponding incoming traffic is dialled up from the long distance board and if the required number is engaged, offering takes place by transferring the call to the local operator. No special trunk train is provided for establishing the connection by either operator.

Subscribers connected to exchanges outside the five-mile circle are charged an extra fee for calls to exchanges which are more than five miles distant and which are not in the five-mile circle. A suitable discrimination is obtained by the first translated digit.

### General Principles of the Bypass System

The Bypass System has been designed so that registration and translation are used only on the relatively small percentage of calls on which it is advantageous in a Step-by-Step System to store

and retransmit the called number. It may be explained that the percentage of calls requiring translation is small because calls are routed through a tandem office only when the traffic is not sufficient to justify direct circuits. As a result, the simplicity and speed of direct switching is preserved and at the same time, the advantages of translation are available.

The use of the bypath connection, provided temporarily between switching stages, reduces the conversational circuit to the simplest elements and also permits the use of separate test and hold conductors. With this arrangement, the test wire is undisturbed by current surges at the moment of release. The number of the impulsing, testing and other controlling relays is reduced owing to their concentration in the common circuits. A more general use of relief relays to widen operating margins is justified

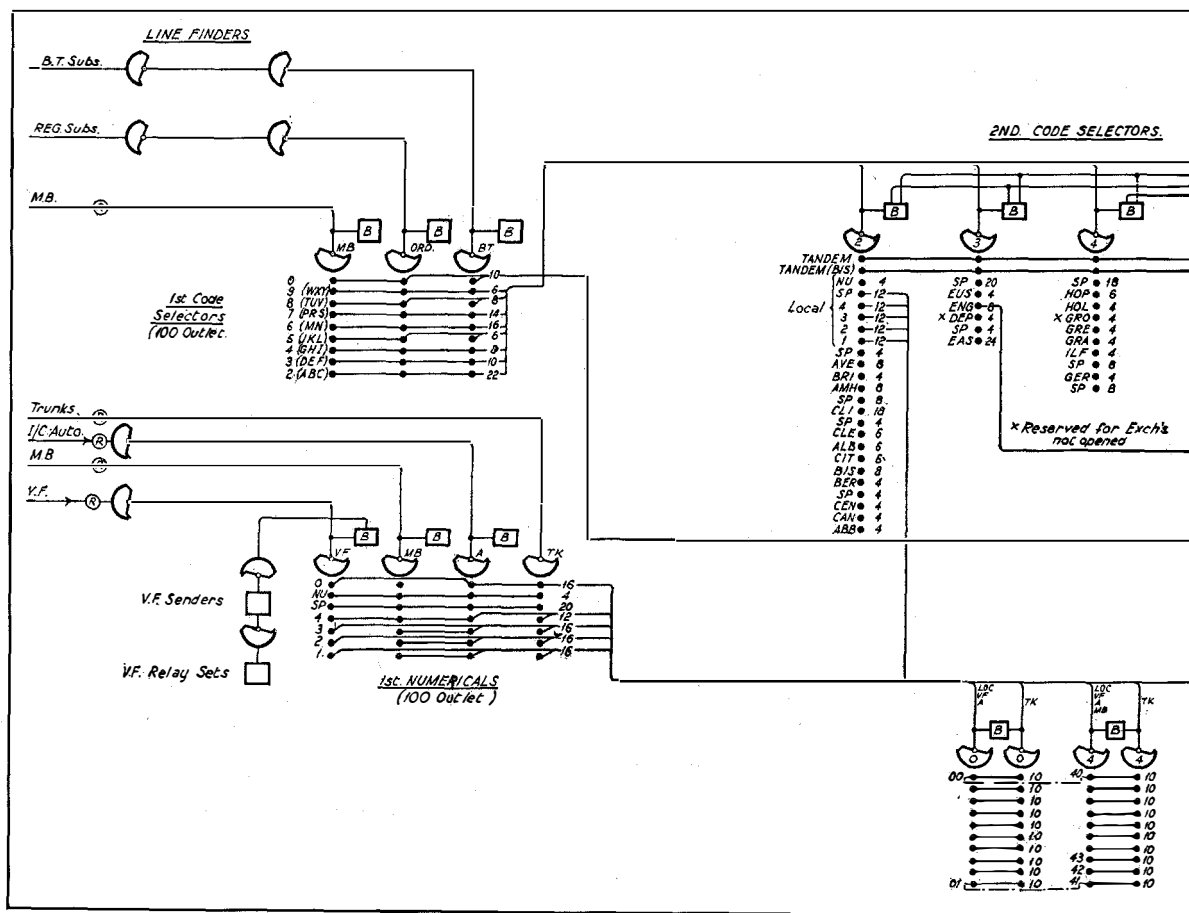

Trunking Diagram,

owing to the relatively small number of the common circuits.

The transmission element is situated in the outgoing relay sets for outgoing calls except on calls from the local manual position and in the penultimate circuit for local and incoming calls. The immediate and interrupted ringing is introduced and controlled at the penultimate stage serving 1000 lines.

Fifty-one contact single motion switches are used exclusively, the wipers being arranged to provide 50 or 100 outlets as required. The wipers are assembled in a die cast frame which can be removed and interchanged easily and rapidly, the mechanism being attached to the bank by a single thumb screw.

Connection to the windings of the magnet and the wipers is made by means of a plug and jack, a method that should prove to be a great con-

venience to the maintenance force particularly in meeting variations in traffic intensity. In fact, at certain switching stages, the interchange of mechanisms and busying pegs is sufficient and requires no rewiring. The ability to vary the size of the groups to suit the volume of traffic in various directions is, of course, an advantage common to all single motion switch systems. On account of the completion date specified, it was not possible to include 200 outlet switches on the Advance equipment, but on one group of 2nd code switches, carrying a high volume of traffic, 200 outlets are obtained by the use of duplicate switches. These circuits require only a single relay. One type of relay is used throughout the exchange and it is to be anticipated that the similarity of apparatus will result in improved skill in maintenance.

The new exchange which has an initial equip-

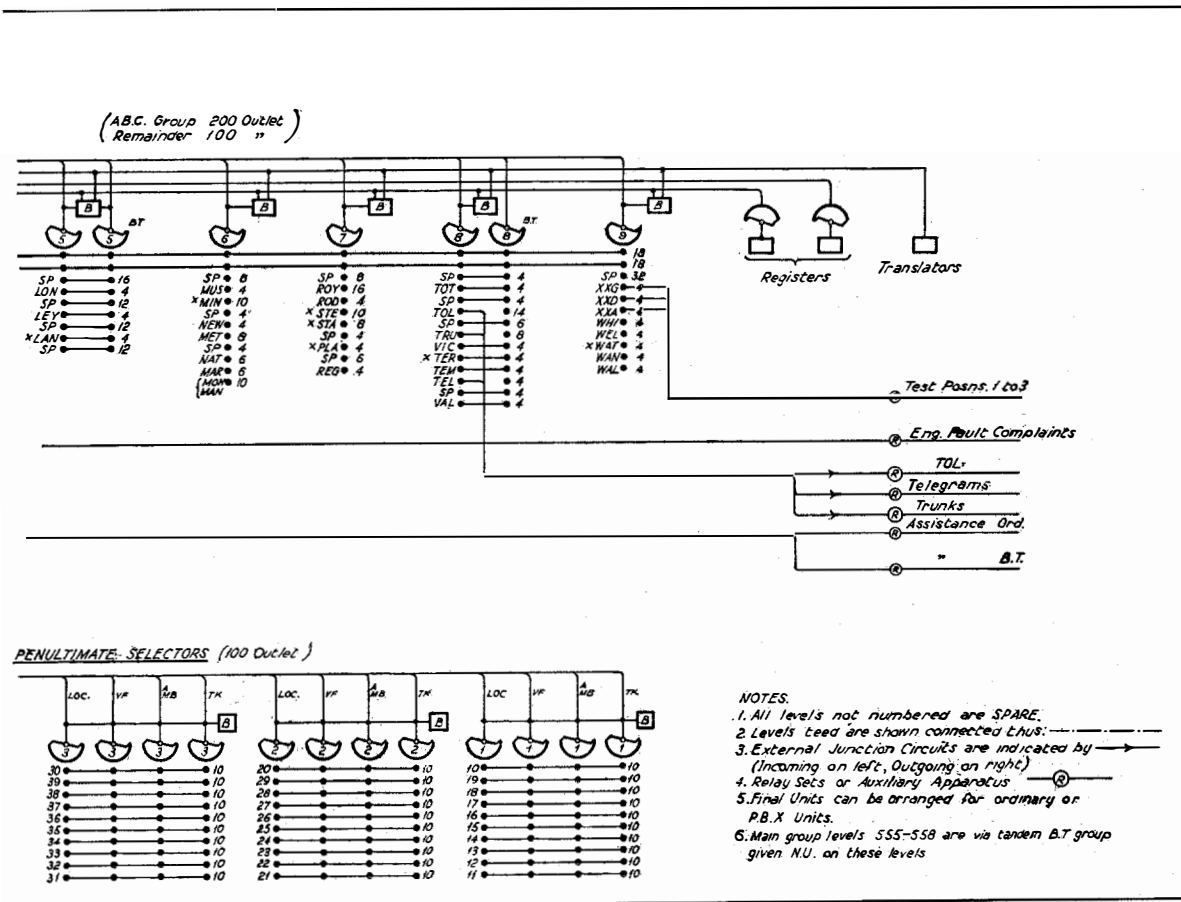

Bypath System.

ment of approximately 3500 lines is situated in a new building close to the Mile End Road. Two thousand lines previously accommodated in adjacent manual exchanges were transferred at the time of opening.

Local calls and direct junction calls are set up directly under the control of the dial, but calls through a tandem exchange are established with the aid of registers and translators. The former store the numerical portion and prepare the

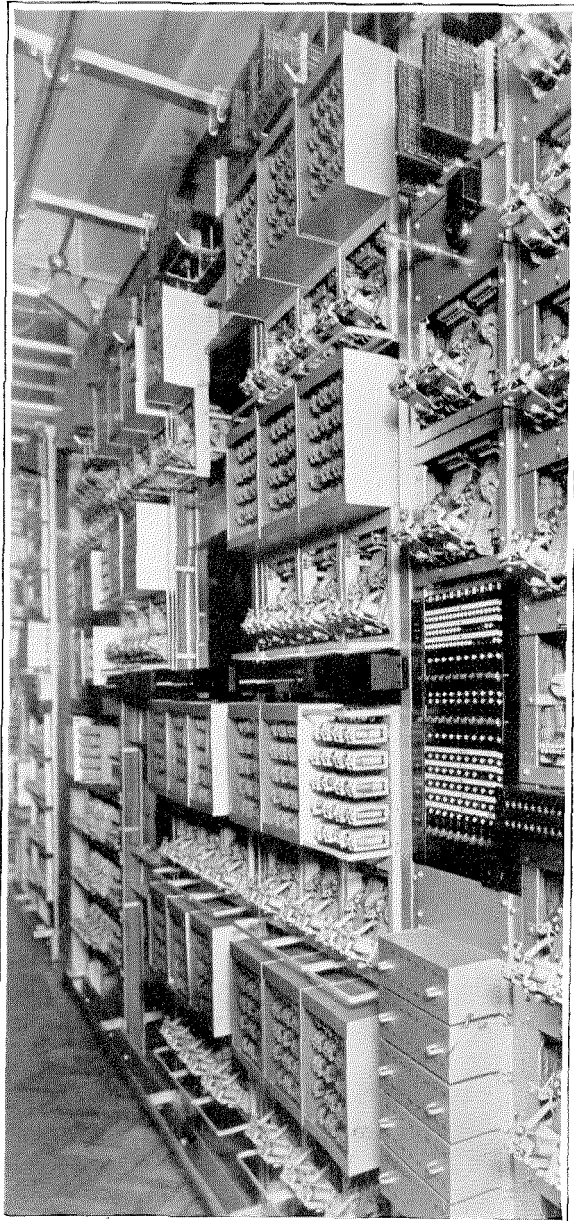

*Registers and Automatic Routers.*

metering conditions, while the latter control the operation of the tandem selectors to reach the required exchange. The registers carry no office strapping whatsoever, so that these circuits are not particular to the trunking arrangements of an exchange or a portion of an exchange.

It is quite a striking fact that the registers are interchangeable and the translator equipment as a whole is identical in each exchange. Advance Exchange is equipped with 20 translators giving capacity for 180 code translations. The circuits in use are cabled to a distributing frame and jumpered across to working exchange terminals, the full 800 possible combinations being cabled from this frame to the Bypasses. A change of translation can be effected by re-running a single twin jumper wire. The registers are associated with the 2nd code Bypasses by 50 point finders which start to rotate when the third digit of the office code is commenced.

For direct junction manual traffic the translator is not employed, but the register is used to send the required number in code.

A new and important arrangement is introduced on outgoing junctions to permit calls to be set up through one of the tandem exchanges when all direct junctions are busy. As most of the direct junctions are working at an occupancy very much lower than the tandem circuits, a considerable economy is obtained by removing approximately 30% of all direct junction circuits. The grade of service is maintained by a slight increase in the number of tandem circuits. A further advantage of this alternative trunking feature is the automatic provision of overflow circuits in the case of junction breakdown. It may be of interest to mention that the normal tendency in a fully equipped exchange is for the volume of traffic in each route to decrease slowly as new exchanges are opened. On the outgoing circuits to the tandem exchange, continuous hunting takes place until the calling subscriber has dialled all 7 digits; if by this time no circuit is available, the busy tone is given.

Incoming junctions from both manual and automatic exchanges terminate on the banks of finders which are operated under the control of bypasses. Special arrangements are made to prevent appreciable hunting time being required for these finders. Owing to the low occupancy

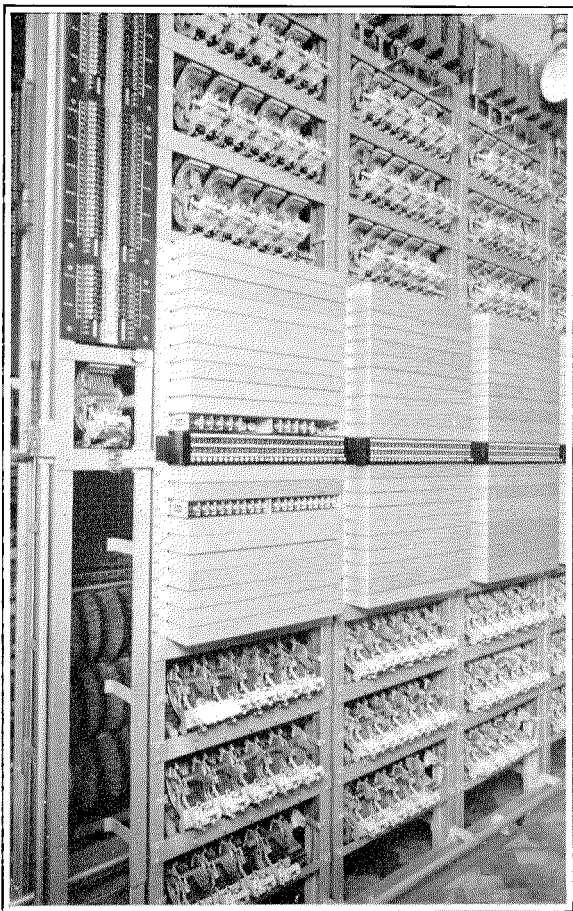

*First Line Finder Bays.*

of the various incoming junction groups and the non-coincidence of the various busy hour peaks, the number of these finders is considerably smaller than the number of junctions. Certain penultimate paths are arranged to receive a discriminating signal from the associated bypaths in order that the supervisory signals may be suitable to the originating exchange.

For the trunk train, a penultimate path without feeding bridge is equipped; these circuits are controlled from the ordinary penultimate bypath and the ordinary final path and bypath are used. The requirements specified for these circuits are:

- Immediate offering on busy lines.
- Immediate connection on accepted calls.
- Complete control of ringing.
- Discrimination between outlet busy and subscriber busy.

On long distance calls in either direction when the resistance of either subscribers' loop is

greater than a certain value, the resistance of the feeding bridge is reduced giving increased transmitter current to improve transmission.

The use of single motion switches and common control circuits also allows greater flexibility to be given to P.B.X. line allocation at the final stage. Any line in the exchange may become a P.B.X. and the lines serving a single P.B.X. subscriber need not be consecutive, provided two different P.B.X. groups do not overlap. Any number may be used for the first line of a P.B.X. and the usual night facilities are provided.

Message register circuits are available for recording the number of calls finding any particular subscriber engaged. If this quantity is found to be excessive and if it is necessary to convince the subscriber that incoming calls are being lost, the overflow calls may be filtered at a manual board.

The way in which the automatic routine test

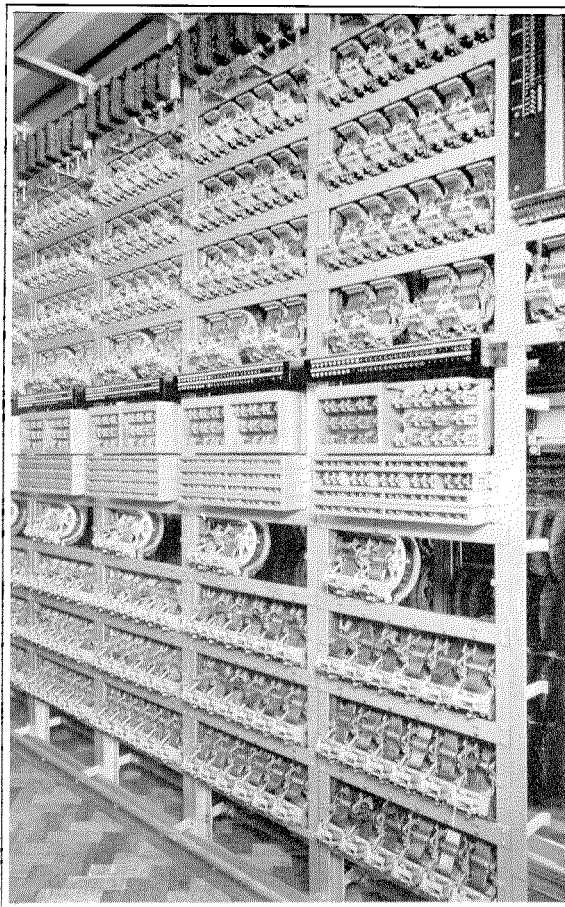

*First Stage Bays.*



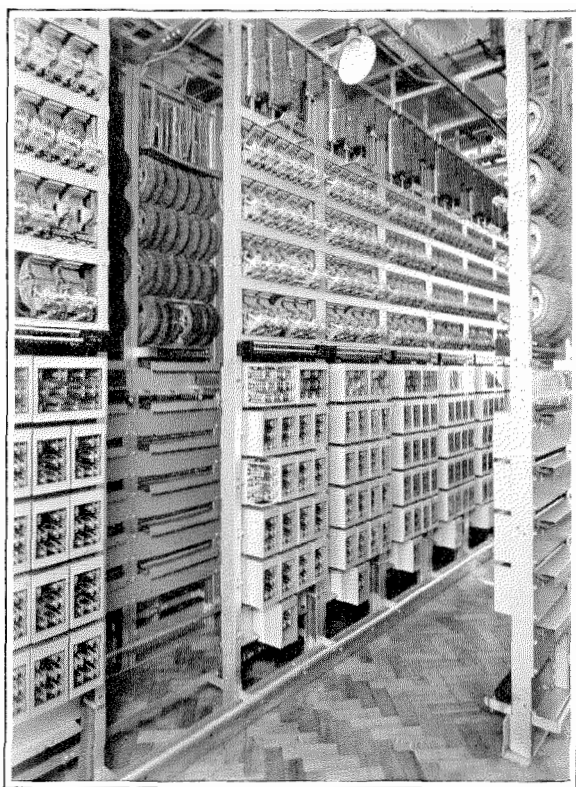

*Penultimate Stage Bays.*

circuits have been designed in conjunction with the circuits to be tested is illustrated by the fact that the switches and wiring normally used to associate the bypaths with the paths are employed also to provide access for the routine tester. Not only does this arrangement permit the testing of this wiring, but it saves a considerable amount of material and installation effort. The relatively large number of access wires makes it possible to provide a comprehensive circuit check very rapidly. Another feature associated with the automatic routiners is an arrangement to enable these circuits to perform a patrolling function during the busy hours of the day. The rapid test which is made in this way is not intended to indicate the nature of a fault but rather to give an alarm. If the type of fault is not obvious, it can be readily obtained by setting the routiner to apply its normal function. This fault detection is carried out without adding any traffic load to the switches.

No attempt has been made in this paper to

describe in detail such items as the Main Distributing Frame, the Link Frames, the Test Jack Frame and the Power Board, which are all of the conventional design. Details of the switch quantities and the circuit operations have been omitted as it is considered that these items are not of such general interest as the switching methods employed and the facilities provided.

### *Special Facilities Provided*

An automatic traffic recorder is installed which registers on a small number of meters the traffic carried by any group of switches in the exchange. In this way, it is possible to find very easily any group which is under or over switched. The recording meters may be rapidly associated with any one of three groups to be observed by means of switching keys. One hundred meter circuits mounted on a bay two feet wide are sufficient to record the busy hour load of every group in Advance Exchange in three days. Photographed results record the traffic in work hours without involved calculation. Plugged out circuits are recorded as engaged throughout the test.

In addition to the overflow meters normally provided, facilities are also available to record the traffic to any exchange obtained over the common tandem circuits.

To supplement the usual dial speed tester on the test desk, an automatic dial speed tester may be connected by calling a special code, the dial speed being indicated by tones.

The release of the connection is controlled by the caller, but to prevent a subscriber being held by the caller failing to release properly, special supervisory circuits are fitted to release the connection after a predetermined delay. The offending circuit is then indicated by a P.G. lamp associated with either the incoming junctions or the first path. Subscribers failing to dial the full number of digits are also cut back to these circuits. Maintenance supervision, therefore, is restricted to a comparatively small number of circuits and the tracing back of the calls through the selecting stages is avoided.

### *Equipment Arrangements*

The bays are fitted back to back in rows, each bay containing all the apparatus associated with

a number of circuits. The relays, lamps and jacks are arranged at a convenient height so that the use of ladders is reduced to a minimum. The bypaths and more important circuits are mounted on plug and jack panels fitted with transparent covers in order that the condition of

a circuit may be clearly observed. Team work is obtained with the bypaths, facilities being provided by a single key, to transfer when necessary, the control of a group of talking circuits from one bypath to another.

Fuse panels associated with each suite of bays are arranged at the end of each suite so that a very simple power distribution scheme is provided. The power plant comprises duplicate batteries, machines and ringers. A small 50-volt booster battery is installed for metering purposes.

The manual boards are equipped with short distance toll circuits, assistance circuits, changed number circuits, interception circuits and a service P.B.X. The terminating circuits include the transmission elements, the cord circuit including only switching relays. In the outgoing multiple, combined designation strips and lamp jacks are used to indicate an idle circuit when the speak key is thrown. In order to enable the assistance operators to supervise a subscriber who has reported difficulty in obtaining a number, the 0 level circuits are arranged so that the operator can reconnect them to a first Bypath by throwing a key. In this condition, the operator can listen to the dial impulses and any tones on the circuit.

All ironwork is finished with aluminum paint and lacquer.

### *Installation*

The arrangement of the equipment on fully cabled bays lends itself to very rapid installation. The erection of the main superstructure, the frames, grading frames and apparatus racks and the running of the cables can be completed before the arrival of the automatic bays. As each bay is self-contained and wired out to terminal strips, it can be routine tested completely prior to shipment and again very shortly afterwards when fully cabled in position.

### *Acknowledgment*

In conclusion, the authors wish to place on record their sincere appreciation of the co-operation received from all Departments of the General Post Office. The vast amount of examination speedily completed and in fact, the satisfactory execution of the installation as a whole,

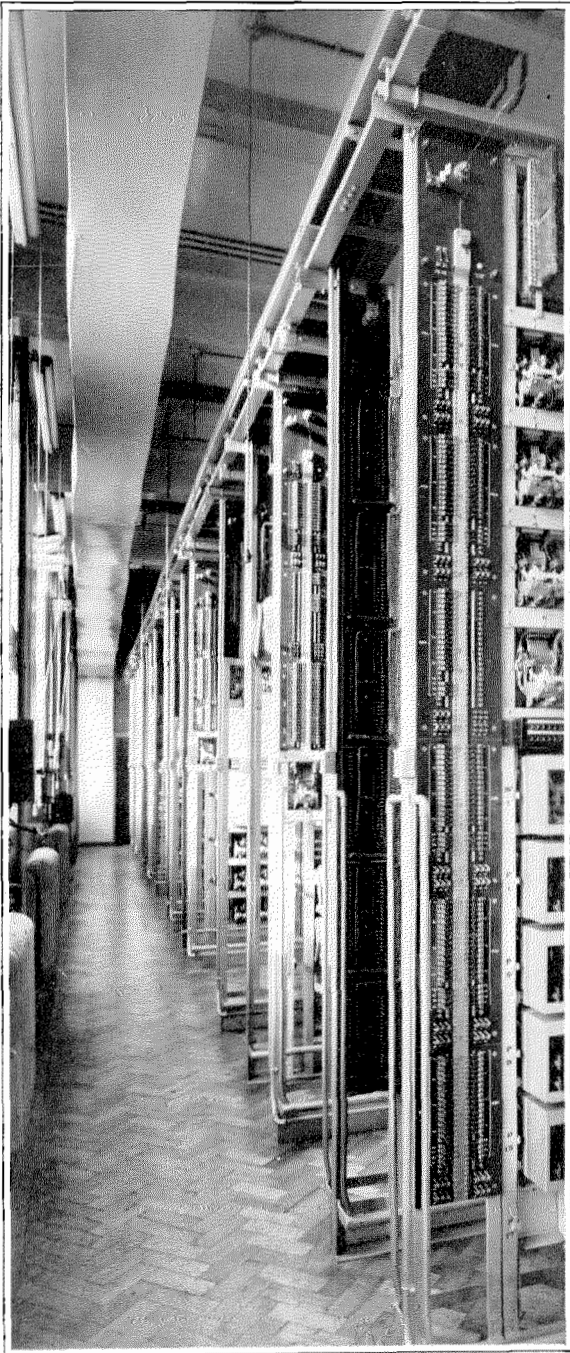

*Suite Fuse Panels.*

could scarcely have been achieved had not this spirit of a real desire to help been present. It has been a great pleasure to all who have been concerned in this installation to have been able to work under such excellent conditions.

The authors also desire to express their thanks to the Engineer-in-Chief for permission to publish this article and the accompanying illustrations.

### ***Bibliography***

R. W. Fraser, "Sloane Exchange, London," *Electrical Communication*, October, 1928.

E. P. G. Wright and J. H. E. Baker, "The Bypass Automatic Telephone System," *The Post Office Electrical Engineers' Journal*, July, 1931.

"Alternative Trunking for Telephone Traffic in a Multi-Office Area," *Electrical Communication*, October, 1931.

E. P. G. Wright and J. H. E. Baker, "The Bypass Automatic Telephone System." A paper read before the Institute of Electrical Engineers in London on January 19, 1933.

# 7-A2 Rotary Automatic Telephone System

By L. SCHREIBER and W. HATTON

*Les Laboratoires, Le Matériel Téléphonique*

## PART II

EDITOR'S NOTE: *As stated in the April, 1933 issue of ELECTRICAL COMMUNICATION, this paper is being published in three parts. Part I, in that issue, dealt with the apparatus and equipment in the 7-A2 Rotary System and the present installment, Part II, describes the manner in which the apparatus is employed to form a complete switching unit.*

### Call Finding Apparatus

THE Rotary system has always employed line finders in preference to preselectors, and from the year 1912 to the year 1923 a finder with 60 outlets was considered to be the most economical. Improvements in design and the technique of manufacture caused the number of outlets to be increased from 60 to 100, and the well-known 100-point gear-driven finder has given satisfactory service in Rotary installations from the year 1923 to the present time.

The 7-A2 system uses line finders of 200 outlets, and it is interesting to make a comparison between the three different switch capacities.

For a given traffic of 1.5 E.B.H.C., the following table shows the number of finders required:

Switch Capacity	Number per Group	Number per Line
60 Outlets	9	0.15
100 "	13	0.13
200 "	20	0.10

If we consider the line finder alone, the most economical capacity depends on efficiency and cost, the latter increasing with the number of outlets. There are, however, other factors which must be taken into consideration. In exchanges using the 60-point line finder, and also those using the 100-point finder, secondary finders are necessary, and while economical from the switch quantity point of view, they require a large amount of multiple cabling, and a jumpering field to enable the traffic to be smoothly distributed over the groups of secondary finders.

A complete cost calculation cannot be made without considering such factors as the number of bays required to mount the finders, the amount of cabling required between the finder terminals, main frame and final selectors, floor space, installation and maintenance costs.

With the introduction of 200-point finders, secondary line finders have been eliminated except for a small quantity which are used to carry the busy hour peak traffic. This arrangement brings the subscribers' line nearer to the 1st group selector and register circuits, with the following advantages:

1. Discriminatory functions of the register circuits with reference to classes of subscribers, restricted and unrestricted toll service and pay-stations are easily arranged without the formation of special groups.
2. Decreases maintenance and makes possible the automatic identification of faulty lines and incompletely dialled connections.
3. Line finders and finals can be mounted on adjacent bays, with factory made cable for interconnecting the two bays. While reserving the possibility of jumpering, it is expected that, in practice, very little re-cross connection will be necessary, because the 200-line group is already sufficiently large to smooth out the traffic and prevent unequal loading of finders and finals.
4. Reduces floor space and facilitates equipment layouts (see Typical Switch Room Layout, Figure 31).
5. Reduces maintenance by eliminating the cross connecting necessary between first and second finders and the upkeep of jumpering records.

With reference to the finders employed for carrying the peak traffic, records which have been made in Rotary exchanges employing 100-point line finders indicate very clearly that the total number of finders provided per group rarely function simultaneously. Analysis of

these records shows that, above a certain number of finders, the efficiency falls off very rapidly, or, in other words, a number of finders in each group are required only to absorb the busy hour peaks. As one example, in an exchange provided with 18-line finders for each group of 100 lines, it was found that, of the total volume of traffic during the period of observation, 212 units were carried by finders number 1 to 10, and 53 units by finders 11 to 18, total 265 units. The individual load on the last eight finders, expressed in equated busy hour calls, was found to be as follows:

Finder No.	11—	15,375
"	"	12—12,250
"	"	13—11,375
"	"	14— 5,500
"	"	15— 5,375
"	"	16— 1,875
"	"	17— 1,250
"	"	18— . . . .
		53,000

Finder No. 18 carried no traffic, that is, the number of simultaneous calls never exceeded 17 during the period of observation.

These results confirm the theoretical studies which have been made on the subject of traffic distribution, and justify switching methods which collect the peak traffic occurring in each individual group of finders, merging them on secondary or overflow groups. In practice, this results in a considerable reduction of the number of 1st group selector circuits. By referring to the junction diagram, Figure 32, it will be seen that, in each of the fifty 200-line groups, 15 finders are wired straight to 1st group selectors and 5 are connected over secondary finders. It is estimated that the first 15 finders will carry 287 E.B.H.C. and the last 5 finders 13 E.B.H.C. The finder-starting circuit is arranged so that the last 5 finders are not called for until each one of the first 15 is engaged. When merged together, the individual group peak traffic totals 650 E.B.H.C., carried by 50 secondary finders divided into 3 subgroups.

The 15 normal and 5 peak traffic finders are of the same type and mount together on the same bay with no difference in the ribbon cable multiple (see Figures 10 and 11, Part I). It is therefore easily possible to change the distri-

bution and to connect as desired a greater or smaller number of finders direct to 1st group selectors. In addition to the finders used for call finding, one finder is provided in each 200-line group for holding and identifying faulty lines and permanent loops. The same finder is used also for identifying malicious callers. Further information on this operation will be given in Part III.

### *Register Connecting Link*

An improvement in the method of connecting the register circuits with the calling lines has been made. The register chooser formerly associated with each switching link circuit has been abandoned in favour of a Register Link Circuit, which comprises two finders, one having access to 100 switching links, and the other to 100 register circuits. Between the two finders, a small group of relays is connected to control their rotation, and to make the connection between the calling link and the register circuit. The link finders are located on the same row as the 100 switching links they serve, and the register finders are located together near the register circuit bays. In addition to hunting for and connecting a switching link with a free register, these circuits are used as access circuits for routine testing of line finders, 1st group selectors and registers and, when necessary, for connecting multi-metering circuits.

The economy resulting from the register link scheme as compared with the former individual register chooser scheme is twofold:

1. A reduction of 55% in the number of switches required. The reduction in the number of arc terminals is approximately 10%, but a considerable simplification of the cabling is obtained.
2. A reduction of 10% in the number of register circuits. Theoretically only 8 groups of 19 register links are required for the scheme shown in Figure 32, but 10 groups of 16 are provided, thus permitting a uniform cabling scheme and switchrack layout.

Ease of maintenance has not been overlooked, and lamps are associated with the link circuits to enable calls to be traced readily from both registers and 1st group selectors.

### *Register Circuits*

It is the intention to describe the circuits and

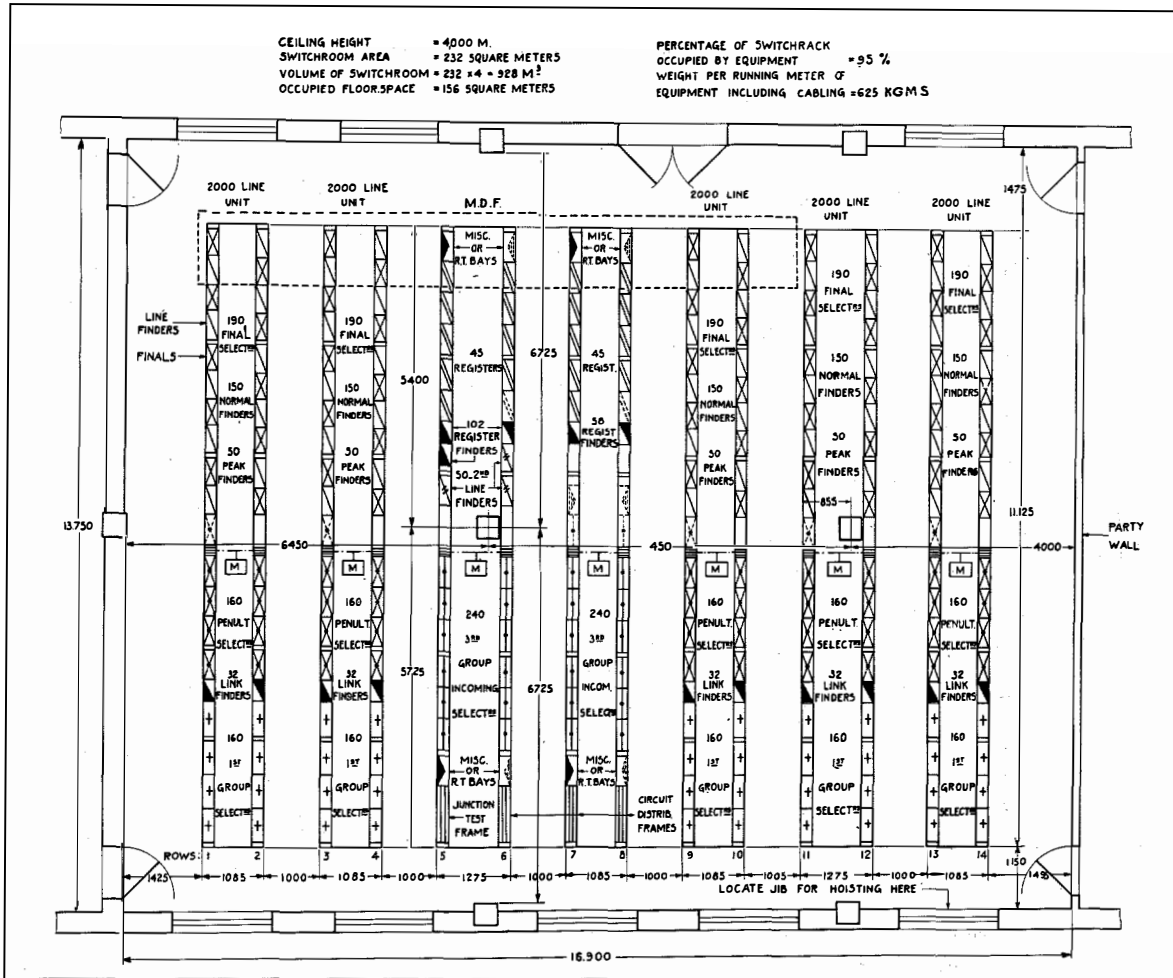

Figure 31—Typical Switchroom Layout for 10,000 Lines, Calling Rate B.H.C. 1.5—Holding Time 2 Minutes.

the facilities given in Part III of this paper, but it is interesting to note in passing some of the outstanding improvements which have been incorporated in the new register circuits.

One set of counting relays is used for receiving the digits dialled up to a maximum of six digits. The same set of relays is used for each digit, and a record is transferred to recording relays. The different stages of the instepping or reception of the dial impulses are controlled by a sequence switch. The outstepping or selection control comprises a set of counting relays which are wired to the terminal strip and connected to the instepping recording relays as desired, so that it is easily possible to arrange for different numbering schemes and to change the routing

of different classes of connections. Selections are controlled also by a sequence switch, and the number of selections can be varied from one to seven.

The register circuits mount five per bay.

### Group and Final Selectors

The group selector has been maintained as a 10-level switch with 20 or 30 outlets per level, as required. At the first, second and third stages, a level capacity of 30 outlets can generally be used with advantage, and in some cases 2 levels giving access to 60 junctions is justified. As the switching unit of the Rotary system is 200 lines, the final selector has access to 200 lines, the penultimate selector to 2,000 lines, and the

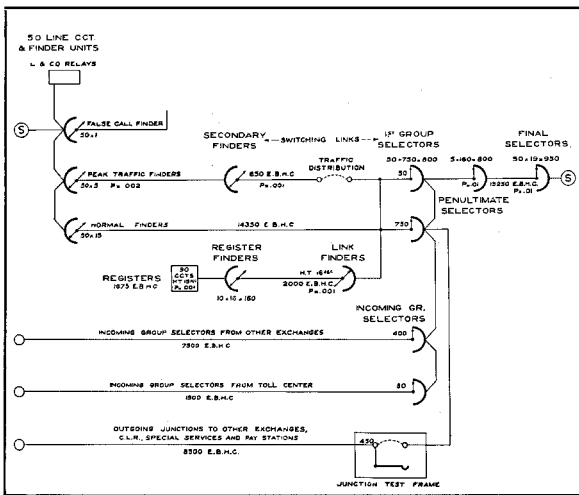

Figure 32—Typical Junction Diagram for 10,000 Lines, E.B.H.C. 1.5 Per Line.

1st group selector to 20,000 lines. Each level of the 1st group selector, and also the incoming group selectors, represents 2,000 lines, and where the exchange unit is 10,000 lines, each of the five 2,000 line levels of the incoming group selectors may be doubled, and the number of outlets therefore increased to 60. This arrangement enables the number of penultimate selectors to be reduced.

The 1st group selector levels can be used in a variety of ways depending on the area layout and capacity. In the simplest case of a single office of 10,000 lines, 1st group, penultimate and final selectors are necessary. For completing local connections, the 1st group selector requires five levels cabled to penultimates, and the remaining five, for example, may be used as follows: One for CLR service, one for pay-station service, one for special services and two as a reserve for future growth. For a multi-office area of five 10,000 line units, five local levels are used and four outgoing to the other four exchanges. CLR, pay-station and special services are reached over special service group selectors cabled to the remaining level. In this layout, local calls are completed over the same number of selectors as in a single 10,000 line exchange, but inter-exchange calls require an additional selector (incoming 3rd group).

As compared with the total number of switches required by the present 7-A1 system for a calling

rate of 1.5 E.B.H.C., the improved system requires 1275 fewer switches. The following summary shows this saving by switch groups:

	7-A1 Number Required	7-A2 Number Required
Line Finders.....	1300	1000
False Call Finders.....	50	50
Secondary Finders.....	715	50
Register Finders.....	715	320
1st Group Selectors.....	715	800
Penultimate ".....	800	800
Final ".....	950	950
Incoming ".....	400	400
Toll ".....	80	80
Wire Chief ".....	50	
Add. Finals for P.B.X.....	Variable	Variable
Total.....	5725	4450

The total number of arc terminals is approximately the same for both systems, and therefore the 7-A2 system has the advantage of a 22% reduction in the number of brush members, driving magnets, gears and shafting. Maintenance is also correspondingly less since there are 1,275 fewer switches to inspect, routine and record.

**Switchroom Layout**

The switching scheme described above permits a very attractive switchroom layout, maintenance facility being the chief consideration with due regard to the amount of floor space occupied.

The switchrack layout is planned to mount the equipment as far as possible in units of 2,000 lines, thus facilitating tracing of connections and at the same time reducing the amount of inter-bay and multiple cabling. The register circuits are placed on switchracks in the centre of the room with the selectors at each side.

The layout shown in Figure 31 requires 14 switchracks arranged in pairs with a shaft motor to each pair.

The register circuits and register finders are mounted on the racks numbered 5, 6, 7 and 8, together with the group selectors carrying the toll and incoming junction traffic. Eighteen bays, each carrying 5 register circuits, are equipped, and space is left for an additional 2 bays, enabling the number of register circuits to

be increased from 90 to 100. Five bays of register finders are located on the same racks. Each bay has a capacity of 34 finders, and the arcs of all finders are connected in multiple.

Racks numbered 1 to 4 and 9 to 14 are similarly arranged and each pair of racks carries complete line and selector equipment for 2,000 lines.

The line finder and final selector bays are

mounted in pairs, and occupy approximately half the rack length. The penultimate selectors for the 2,000 lines (10 levels each with access to final selectors for 200 lines) are placed adjacently and consist of 8 bays of 20 selectors each. Two bays of link finders and 8 bays of 1st group selectors complete the selector equipment. Of the two remaining bays, one is for locating routine test equipment and the other,

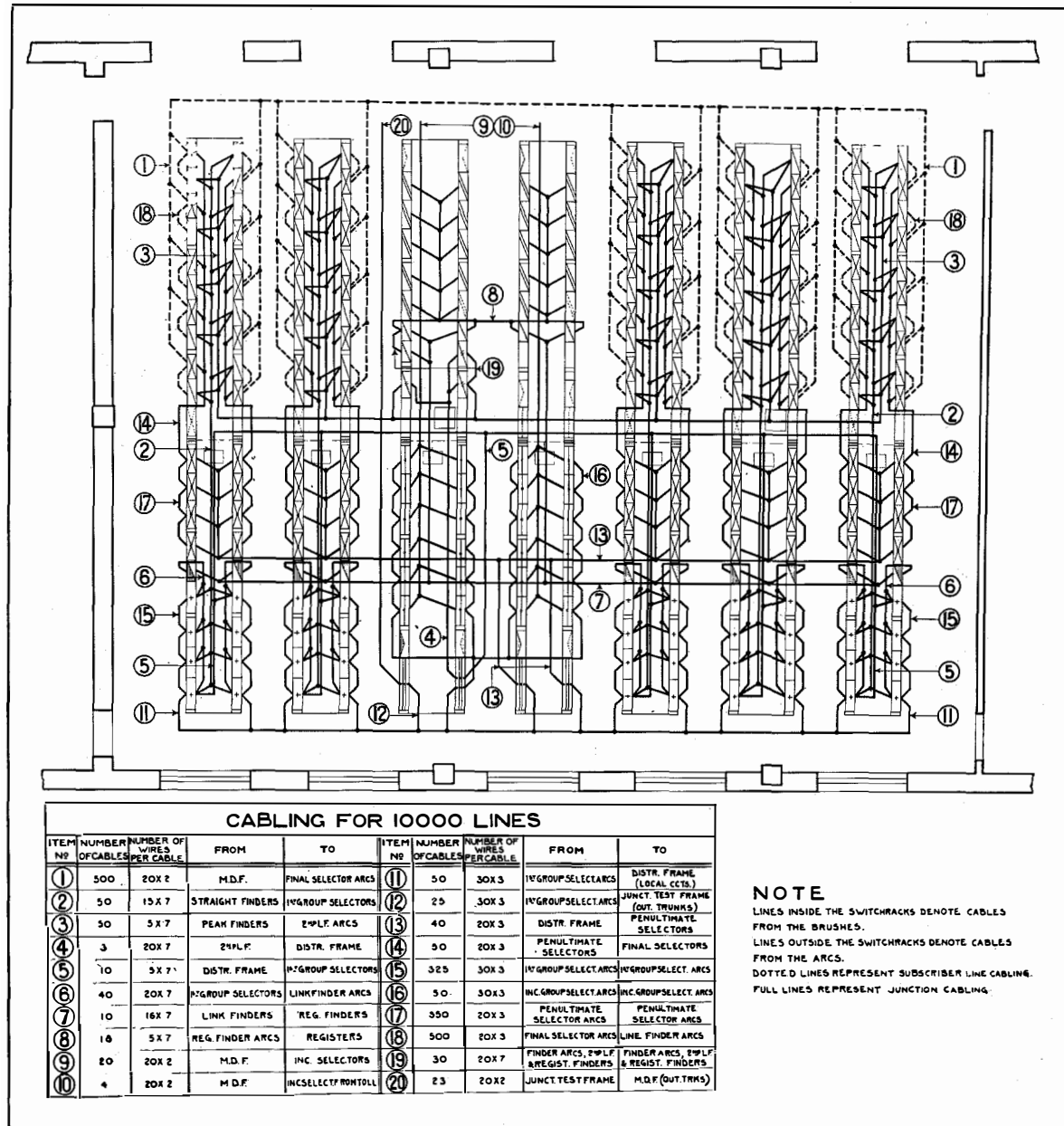

Figure 33—Switchrack Layout.



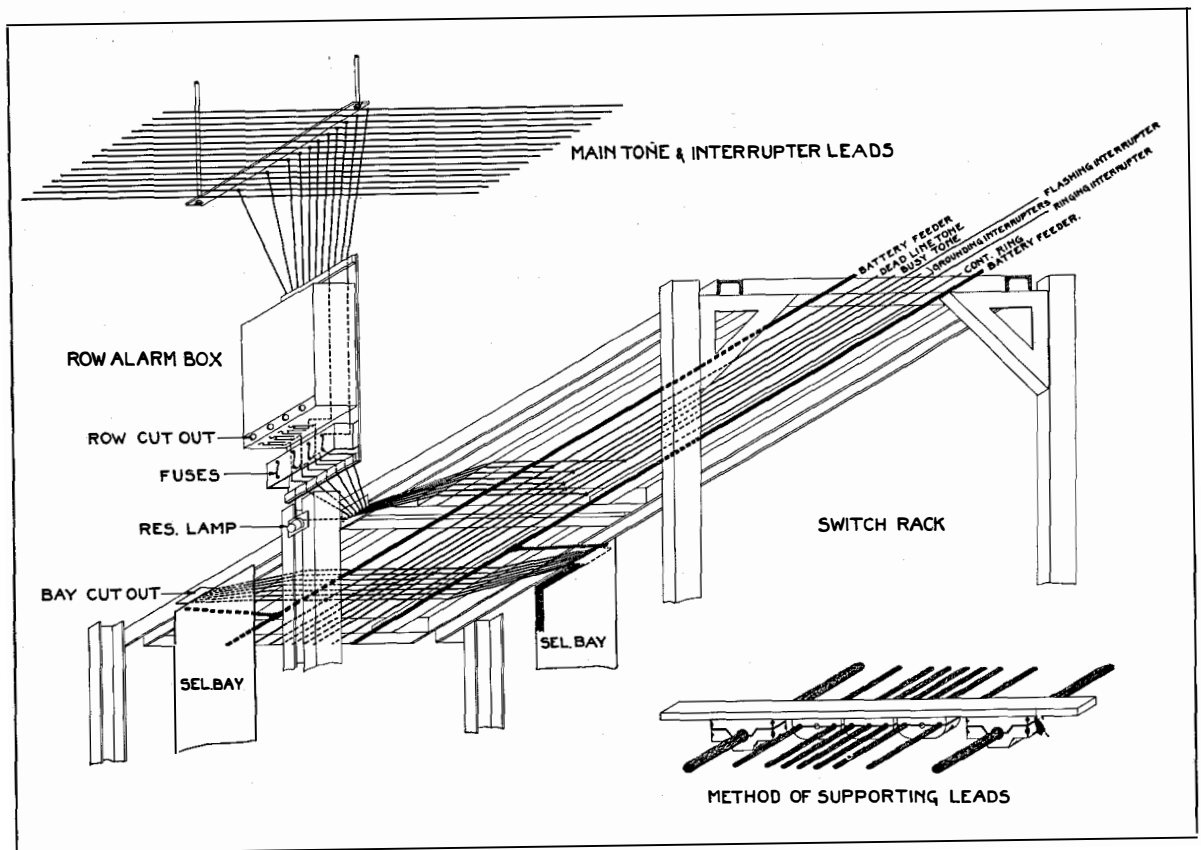

Figure 34—Cabling Scheme.

for future growth. Of the 200 line finders, 150 are connected to 1st groups on the same racks, and the remaining 50 to the arcs of the secondary finders which are equipped on racks 5 and 6. The 50 1st group selectors associated with the secondary finders are divided over the five 2,000 line groups, 10 in each group, thus making a total of 160 1st group selectors in each group.

The switchroom dimensions are as follows:

Length.....	16.900 meters
Breadth.....	13.750 "
Height.....	4.000 "

The layout shown requires an area of 232 square meters, a reduction of approximately 34% compared with the present 7-A1 system.

An important advantage of this switchroom layout is that it permits equipments of less than 10,000 lines to be installed with practically no lost floor space. The equipment can be ex-

tended, when necessary, in a logical manner, and without disturbing the existing switchracks. For an initial equipment of 2,000 lines with an ultimate of 10,000 lines, rows 3 to 8 inclusive would be installed, and extensions made in 1,000 or 2,000 line units on rows 1, 2 and 9 to 14.

### Cabling Scheme

The installation cabling scheme is simple and needs little explanation. Figure 33 shows the cabling with the switchroom as a background, from which the length of each cable can easily be estimated. As explained in Part I, each bay is equipped with terminal strips, with the object of confining the installation cabling to the straight-forward interconnection of the bays without touching the automatic equipment. This can be done with local labour and, as soon as the cable racks are in position, all cables can be run

and formed ready for the reception of the bays. The largest item is the subscriber's line cabling from the final selectors to the Main Distributing Frame. This requires 500 twenty pair cables. Where service meters are required, 500 20 x 3 cables may be run to the M.D.F. and connection with the meters made by separate cables between the horizontal side of the M.D.F. and the meter rack. When the meter rack is located in the switchroom or at some distance from the M.D.F., it is preferable to run separate cables from the final selector bays. Figure 33 does not show the service meter cabling. Cables extending over more than two switchracks are relatively few, items 11, 12 and 13 being the most important.

### Battery Supply, Ringing and Tone Leads

Heretofore the planning of the miscellaneous cabling has not received as much attention as it deserves. The tendency has been to conceal it as much as possible on the top of the switchracks, a practice which perhaps preserved the neat appearance of the exchange but was extremely inconvenient when the time came to locate a fault on one of the common leads, such as the dialling tone supply. The 7-A2 system introduces the method of running all common leads underneath the roof of the switchracks. These are supported by a series of insulators and are clearly visible from the floor, thus enabling the maintenance force to trace their direction and to locate faults. The various leads may be identified by using different coloured insulation or by small labels attached at intervals. To enable rapid location of faults, jack type cutouts are provided per row and per bay (see Figure 34).

### Switchracks and Bays

An improvement in the method of fixing the bays to the switchracks is achieved by the use of a new design of clamp. Floor channel drilling is no longer necessary, and the work of the equipment engineer and installer is simplified. The new clamp is shown in Figure 35, and the switchracks and superstructure of the Victoria Exchange, Bucharest, in Figure 36. The weight of the various bays when fully equipped is as follows:

L.F. Bay.....	260 Kgms.
1st Group Selector Bay.....	330 "
Penultimate ".....	300 "
Final Selector Bay.....	230 "
Link Finder Bay.....	200 "
Register Finder Bay.....	200 "
3rd Incoming Selector Bay.....	300 "
Register Bay.....	240 "

Views of the various bays were contained in Part I, which should be referred to for details of bay construction and equipment.

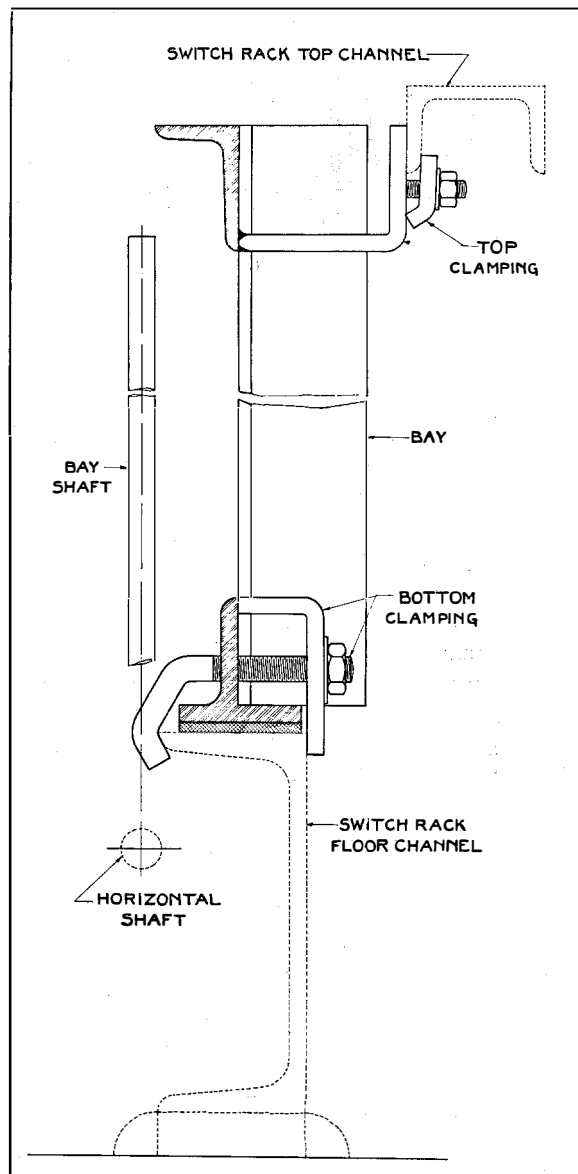

Figure 35—Method of Clamping Bays to Switchrack.

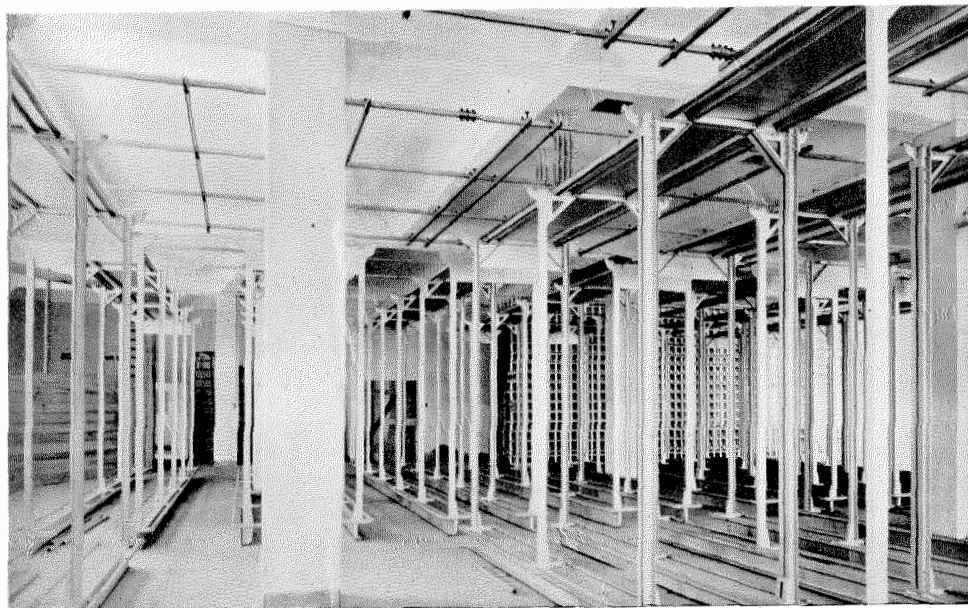

Figure 36—Superstructure of Victoria Exchange, Bucharest, Rumania.

### Power Plant

The type of power plant depends to a large extent on local conditions, the reliability of the mains, and the amount of reserve required in case of mains failure. The tendency in design is always towards simplification of the power equipment and reduction of current consumption of the automatic equipment.

The 7-A2 type equipment requires less current than the 7-A1, and permits a reduction of battery capacity of about 14%. For the equipment

indicated in Figure 31, the battery capacity with a reserve of 4 busy hours is 1,600 A.H., and the busy hour drain is 319 amperes. Corresponding figures for equipment of less than 10,000 lines are:

Equipment.....	2,000	4,000	6,000	10,000 lines
Total Busy Hour Drain, including Switchrack and Ringing Motors	72	132	192	319 amperes
Battery capacity, with reserve of 4 B.H.....	359	660	960	1,600 A.H.

# Telephone and Telegraph Statistics of the World

Compiled by Chief Statistician's Division, American Telephone and Telegraph Company

## Telephone Development of the World, by Countries January 1, 1932

COUNTRIES	NUMBER OF TELEPHONES			Per Cent of Total World	Telephones Per 100 Population
	Government Systems	Private Companies	Total		
<b>NORTH AMERICA:</b>					
United States.....	—	19,690,187	19,690,187	56.17%	15.8
Canada.....	223,186	1,141,014	1,364,200	3.89%	13.1
Central America.....	11,317	14,439	25,756	.07%	0.4
Mexico.....	1,427	92,086	93,513	.27%	0.6
<b>West Indies:</b>					
Cuba.....	485	55,098	55,583	.16%	1.5
Porto Rico.....	589	11,662	12,251	.04%	0.8
Other W. I. Places*.....	7,985	13,970	21,955	.06%	0.3
Other No. Am. Places*.....	100	11,900	12,000	.03%	3.3
Total.....	245,089	21,030,356	21,275,445	60.69%	12.5
<b>SOUTH AMERICA:</b>					
Argentina*.....	—	313,598	313,598	.90%	2.7
Bolivia.....	—	2,093	2,093	.01%	0.1
Brazil*.....	680	165,024	165,704	.47%	0.4
Chile.....	—	48,130	48,130	.14%	1.1
Colombia*.....	2,500	27,000	29,500	.08%	0.3
Ecuador.....	2,968	3,300	6,268	.02%	0.3
Paraguay.....	—	2,931	2,931	.01%	0.3
Peru.....	—	14,632	14,632	.04%	0.2
Uruguay.....	—	29,691	29,691	.08%	1.5
Venezuela.....	606	21,577	22,183	.06%	0.7
Other So. Am. Places*.....	2,760	—	2,760	.01%	0.5
Total.....	9,514	627,976	637,490	1.82%	0.7
<b>EUROPE:</b>					
Austria.....	239,809	—	239,809	.69%	3.5
Belgium (February 29, 1932).....	313,022	—	313,022	.89%	3.8
Bulgaria.....	17,551	—	17,551	.05%	0.3
Czechoslovakia.....	150,284	18,859	169,143	.48%	1.1
Denmark (March 31, 1932).....	14,899	349,609	364,508	1.04%	10.1
Finland.....	1,597	125,900	127,497	.36%	3.4
France.....	1,228,879	—	1,228,879	3.51%	2.9
Germany (March 31, 1932).....	3,113,655	—	3,113,655	8.88%	4.8
Great Britain & No. Ireland.....	2,080,056	—	2,080,056	5.93%	4.5
Greece*.....	13,000	—	13,000	.04%	0.2
Hungary.....	116,597	—	116,597	.33%	1.3
Irish Free State (March 31, 1932).....	31,994	—	31,994	.09%	1.1
Italy (June 30, 1931).....	—	440,392	440,392	1.26%	1.0
Jugo-Slavia.....	37,488	—	37,488	.11%	0.3
Latvia (March 31, 1932).....	53,883	—	53,883	.15%	2.8
Netherlands.....	325,799	—	325,799	.93%	4.1
Norway (June 30, 1931).....	118,355	78,900	197,255	.56%	7.0
Poland.....	101,939	92,209	194,148	.55%	0.6
Portugal.....	10,754	31,000	41,754	.12%	0.6
Roumania.....	—	50,050	50,050	.14%	0.3
Russia§ (October 1, 1931).....	462,931	—	462,931	1.32%	0.3
Spain.....	—	252,500	252,500	.72%	1.1
Sweden.....	558,956	1,649	560,605	1.60%	9.1
Switzerland.....	324,088	—	324,088	.93%	7.9
Other Places in Europe*.....	100,520	14,457	114,977	.33%	1.4
Total.....	9,416,056	1,455,525	10,871,581	31.01%	2.0
<b>ASIA:</b>					
British India*.....	20,500	34,000	54,500	.16%	0.02
China*.....	85,000	65,000	150,000	.43%	0.03
Japan (March 31, 1932).....	919,605	—	919,605	2.62%	1.4
Other Places in Asia.....	116,016	15,332	131,348	.37%	0.1
Total.....	1,141,121	114,332	1,255,453	3.58%	0.1
<b>AFRICA:</b>					
Egypt.....	44,440	—	44,440	.13%	0.2
Union of South Africa#.....	113,122	—	113,122	.32%	1.4
Other Places in Africa*.....	93,176	1,335	94,511	.27%	0.1
Total.....	250,738	1,335	252,073	.72%	0.2
<b>OCEANIA:</b>					
Australia (June 30, 1931).....	498,055	—	498,055	1.42%	7.7
Dutch East Indies.....	46,104	4,250	50,354	.14%	0.1
Hawaii.....	—	25,789	25,789	.07%	6.5
New Zealand#.....	160,779	—	160,779	.46%	9.9
Philippine Islands.....	*6,000	20,414	26,414	.08%	0.2
Other Places in Oceania*.....	3,458	778	4,236	.01%	0.2
Total.....	714,396	51,231	765,627	2.18%	0.9
<b>TOTAL WORLD.....</b>	<b>11,776,914</b>	<b>23,280,755</b>	<b>††35,057,669</b>	<b>100.00%</b>	<b>1.8</b>

\* Partly estimated. # March 31, 1932. § U.S.S.R., including Siberia and Associated Republics.

†† Includes approximately 12,500,000 automatic or "Dial" telephones, of which more than 50% are in the United States.

## Telephone Development of Large Cities

### January 1, 1932

Country and City (or Exchange Area)	Estimated Population (City or Exchange Area)	Number of Telephones	Telephones per 100 Population
<b>ARGENTINA:</b>			
Buenos Aires.....	2,875,000	170,352	5.9
<b>AUSTRALIA:</b>			
Adelaide.....	325,000	27,999	8.6
Brisbane.....	317,000	24,559	7.7
Melbourne.....	1,031,000	91,305	8.9
Sydney.....	1,256,000	106,231	8.5
<b>AUSTRIA (January 1, 1931):</b>			
Graz.....	165,000	9,469	5.7
Vienna.....	2,020,000	155,128	7.7
<b>BELGIUM (January 1, 1931):</b>			
Antwerp.....	519,000	37,795	7.3
Brussels.....	948,000	95,632	10.1
Liege.....	424,000	20,669	4.9
<b>BRAZIL:</b>			
Rio de Janeiro.....	1,650,000	45,180	2.7
<b>CANADA:</b>			
Montreal.....	979,000	192,302	19.6
Ottawa.....	182,200	39,399	21.6
Toronto.....	752,700	206,968	27.5
<b>CHINA:</b>			
Canton.....	1,000,000	4,300	0.4
Hong Kong.....	750,000	13,463	1.9
Peiping.....	1,400,000	12,583	0.9
Shanghai.....	1,500,000	38,428	2.6
<b>CUBA:</b>			
Havana.....	720,000	42,310	5.9
<b>CZECHOSLOVAKIA:</b>			
Prague.....	870,000	39,658	4.6
<b>DANZIG:</b>			
Free City of Danzig.....	240,000	17,161	7.2
<b>DENMARK:</b>			
Copenhagen.....	780,000	148,378	19.0
<b>FINLAND:</b>			
Helsingfors.....	255,000	34,426	13.5
<b>FRANCE:</b>			
Bordeaux.....	268,000	17,679	6.6
Lille.....	212,000	16,043	7.6
Lyons.....	596,000	31,527	5.3
Marseilles.....	682,000	28,716	4.2
Paris.....	3,000,000	426,024	14.2
<b>GERMANY (March 31, 1932):</b>			
Berlin.....	4,270,000	496,148	11.6
Breslau.....	616,000	42,489	6.9
Cologne.....	741,000	66,768	9.0
Dresden.....	630,000	60,085	9.5
Dortmund.....	534,000	24,702	4.6
Essen.....	649,000	29,726	4.6
Frankfort-on-Main.....	615,000	64,927	10.6
Hamburg-Altona.....	1,595,000	169,670	10.6
Leipzig.....	716,000	67,993	9.5
Munich.....	697,000	75,784	10.9
<b>GREAT BRITAIN AND NO. IRELAND (March 31, 1932):</b>			
Belfast.....	415,000	16,717	4.0
Birmingham.....	1,178,000	53,885	4.6
Bristol.....	412,000	19,524	4.7
Edinburgh.....	441,000	29,599	6.7
Glasgow.....	1,180,000	57,028	4.8
Leeds.....	508,000	22,488	4.4
Liverpool.....	1,184,000	56,487	4.8
London.....	8,900,000	769,928	8.7
Manchester.....	1,094,000	61,889	5.7
Newcastle.....	469,000	18,811	4.0
Sheffield.....	514,000	19,015	3.7
<b>HAWAII:</b>			
Honolulu.....	140,000	17,516	12.5
<b>HUNGARY:</b>			
Budapest.....	1,012,000	77,055	7.6
Szeged.....	136,000	2,381	1.8

## Telephone Development of Large Cities—(Concluded)

January 1, 1932

Country and City (or Exchange Area)	Estimated Population (City or Exchange Area)	Number of Telephones	Telephones per 100 Population
<b>IRISH FREE STATE:</b>			
Dublin (March 31, 1932)	415,000	17,132	4.1
<b>ITALY:</b>			
Genoa	650,000	29,153	4.5
Milan	990,000	78,999	8.0
Rome	945,000	65,173	6.9
<b>JAPAN (March 31, 1932):</b>			
Kobe	804,000	29,849	3.7
Kyoto	977,000	36,729	3.8
Nagoya	934,000	29,238	3.1
Osaka	2,520,000	104,902	4.2
Tokio	3,425,000	155,219	4.5
<b>LATVIA (March 31, 1932):</b>			
Riga	395,000	19,334	4.9
<b>MEXICO:</b>			
Mexico City	1,000,000	50,390	5.0
<b>NETHERLANDS:</b>			
Amsterdam	766,000	52,487	6.9
Haarlem	152,000	11,227	7.4
Rotterdam	605,000	41,096	6.8
The Hague	487,000	46,126	9.5
<b>NEW ZEALAND (March 31, 1932):</b>			
Auckland	207,000	21,579	10.4
<b>NORWAY (June 30, 1931):</b>			
Oslo	250,000	48,524	19.4
<b>PHILIPPINE ISLANDS:</b>			
Manila	385,000	17,631	4.6
<b>POLAND:</b>			
Lodz	824,000	14,330	1.7
Warsaw	1,178,000	57,361	4.9
<b>PORTUGAL:</b>			
Lisbon	595,000	23,318	3.9
<b>ROUMANIA (January 1, 1931):</b>			
Bucharest	630,000	17,103	2.7
<b>RUSSIA (October 1, 1931):</b>			
Leningrad	2,235,000	70,419	3.2
Moscow	2,780,000	90,561	3.3
<b>SPAIN:</b>			
Barcelona	850,000	41,605	4.9
Madrid	850,000	46,851	5.5
<b>SWEDEN:</b>			
Gothenburg	248,000	39,545	15.9
Malmö	130,000	19,419	14.9
Stockholm	436,000	137,999	31.7
<b>SWITZERLAND:</b>			
Basel	148,000	25,456	17.2
Berne	112,000	20,106	18.0
Geneva	144,000	24,079	16.7
Zurich	254,000	46,963	18.5
<b>UNITED STATES:¶</b>			
New York	7,100,000	1,753,380	24.7
Chicago	3,488,000	939,481	26.9
Los Angeles	1,345,000	398,861	29.7
Pittsburgh	1,000,000	225,234	22.5
Total 9 cities over 1,000,000 Population	20,827,000	4,988,907	24.0
Milwaukee	737,600	156,408	21.2
San Francisco	665,000	260,204	39.1
Washington	582,500	194,653	33.4
Minneapolis	508,000	131,914	26.0
Total 11 cities with 500,000 to 1,000,000 Population	7,018,900	1,574,916	22.4
Seattle	408,200	124,617	30.5
Denver	293,200	92,547	31.6
Hartford	237,700	58,361	24.5
Omaha	231,200	66,413	28.7
Total 31 cities with 200,000 to 500,000 Population	9,149,200	1,912,794	20.9
Total 51 cities with more than 200,000 Population	36,995,100	8,476,617	22.9

¶ There are shown, for purposes of comparison with cities in other countries, the total development of all cities in the United States in certain population groups, and the development of certain representative cities within each of such groups.

## Telephone and Telegraph Wire of the World, by Countries

### January 1, 1932

COUNTRIES	Service Operated By (See Note)	MILES OF TELEPHONE WIRE			MILES OF TELEGRAPH WIRE		
		Number of Miles	Per Cent of Total World	Per 100 Population	Number of Miles	Per Cent of Total World	Per 100 Population
<b>NORTH AMERICA:</b>							
United States.....	P.	86,100,000	59.26%	69.3	2,280,000	33.66%	1.8
Canada.....	P.G.	4,985,000	3.43%	48.0	369,000	5.45%	3.6
Central America.....	P.G.	57,000	.04%	0.8	22,000	.33%	0.3
Mexico.....	P.G.	455,000	.31%	2.7	86,000	1.27%	0.5
<b>West Indies:</b>							
Cuba.....	P.G.	302,000	.21%	7.9	14,000	.21%	0.4
Porto Rico.....	P.G.	33,000	.02%	2.1	1,000	.01%	0.1
Other W. I. Places.....	P.G.	95,000	.07%	1.5	6,000	.09%	0.1
Other No. Am. Places.....	P.G.	20,000	.01%	5.5	11,000	.16%	3.1
Total.....		92,047,000	63.35%	54.1	2,789,000	41.18%	1.6
<b>SOUTH AMERICA:</b>							
Argentina.....	P.	1,080,000	.74%	9.2	200,000	2.95%	1.7
Bolivia.....	P.	5,500	.004%	0.2	5,000	.07%	0.2
Brazil.....	P.G.	525,000	.36%	1.2	110,000	1.62%	0.3
Chile.....	P.	180,000	.13%	4.2	30,000	.44%	0.7
Colombia.....	P.G.	45,000	.03%	0.5	21,000	.31%	0.2
Ecuador.....	P.G.	6,000	.004%	0.2	4,500	.07%	0.2
Paraguay.....	P.	7,000	.005%	0.8	2,500	.04%	0.3
Peru.....	P.	45,000	.03%	0.7	13,000	.19%	0.2
Uruguay.....	P.	46,000	.03%	2.4	7,500	.11%	0.4
Venezuela.....	P.G.	56,000	.04%	1.7	6,500	.10%	0.2
Other So. Am. Places.....	G.	5,500	.004%	1.1	500	.01%	0.1
Total.....		2,001,000	1.38%	2.3	400,500	5.91%	0.5
<b>EUROPE:</b>							
Austria.....	G.	720,000	.50%	10.5	50,000	.74%	0.7
Belgium (November 1, 1931).....	G.	1,389,000	.96%	17.0	30,000	.44%	0.4
Bulgaria.....	G.	58,000	.04%	1.0	8,000	.12%	0.1
Czechoslovakia.....	P.G.	514,000	.35%	3.5	82,000	1.21%	0.6
Denmark (March 31, 1932).....	P.G.	1,065,000	.73%	29.5	8,500	.12%	0.2
Finland.....	P.G.	332,000	.23%	8.9	12,000	.18%	0.3
France.....	G.	4,800,000	3.30%	11.4	522,000	7.71%	1.2
Germany (March 31, 1932).....	G.	14,800,000	10.19%	22.7	239,000	3.53%	0.4
Great Britain & No. Ireland#.....	G.	8,950,000	6.16%	19.3	390,000	5.76%	0.8
Greece.....	G.	17,000	.01%	0.3	33,000	.49%	0.5
Hungary.....	G.	388,000	.27%	4.4	52,000	.77%	0.6
Irish Free State#.....	G.	109,000	.08%	3.7	21,000	.31%	0.7
Italy.....	P.G.	†1,154,000	.79%	2.7	247,000	3.65%	0.6
Jugo-Slavia.....	G.	133,000	.09%	0.9	60,000	.89%	0.4
Latvia (March 31, 1932).....	G.	247,000	.17%	12.8	4,500	.07%	0.2
Netherlands.....	G.	825,000	.57%	10.3	24,000	.35%	0.3
Norway (June 30, 1931).....	P.G.	564,000	.39%	20.0	28,000	.41%	1.0
Poland.....	P.G.	753,000	.52%	2.4	53,000	.78%	0.2
Portugal.....	P.G.	105,000	.07%	1.6	14,000	.21%	0.2
Roumania.....	P.	170,000	.12%	0.9	42,000	.62%	0.2
Russia‡.....	G.	600,000	.41%	0.4	200,000	2.95%	0.1
Spain.....	P.	1,050,000	.72%	4.6	90,000	1.33%	0.4
Sweden.....	G.	1,917,000	1.32%	31.1	43,000	.63%	0.7
Switzerland.....	G.	1,033,000	.71%	25.3	18,000	.27%	0.5
Other Places in Europe.....	P.G.	307,000	.21%	3.7	25,000	.37%	0.3
Total.....		42,000,000	28.91%	7.7	2,297,000	33.91%	0.4
<b>ASIA:</b>							
British India.....	P.G.	365,000	.25%	0.1	435,000	6.42%	0.1
China.....	P.G.	750,000	.52%	0.2	130,000	1.92%	0.03
Japan (March 31, 1932).....	G.	3,330,000	2.29%	5.0	186,000	2.75%	0.3
Other Places in Asia.....	P.G.	358,000	.25%	0.3	147,000	2.17%	0.1
Total.....		4,803,000	3.31%	0.5	898,000	13.26%	0.1
<b>AFRICA:</b>							
Egypt.....	G.	225,000	.16%	1.1	38,000	.56%	0.2
Union of South Africa#.....	G.	484,000	.33%	5.9	32,000	.47%	0.4
Other Places in Africa.....	P.G.	223,000	.15%	0.2	147,000	2.17%	0.1
Total.....		932,000	.64%	0.8	217,000	3.20%	0.2
<b>OCEANIA:</b>							
Australia (June 30, 1931).....	G.	2,518,000	1.73%	38.7	103,000	1.52%	1.6
Dutch East Indies.....	P.G.	244,000	.17%	0.4	28,000	.41%	0.05
Hawaii.....	P.	84,000	.05%	21.3	0	.00%	0.0
New Zealand (March 31, 1932).....	G.	595,000	.41%	36.8	26,000	.39%	1.6
Philippine Islands.....	P.G.	60,000	.04%	0.5	11,000	.16%	0.1
Other Places in Oceania.....	P.G.	8,500	.01%	0.4	4,000	.06%	0.2
Total.....		3,509,500	2.41%	4.1	172,000	2.54%	0.2
<b>TOTAL WORLD.....</b>		<b>145,292,500</b>	<b>100.00%</b>	<b>7.3</b>	<b>6,773,500</b>	<b>100.00%</b>	<b>0.3</b>

NOTE: Telegraph service is operated by Governments, except in the United States and Canada. In connection with telephone wire, P. indicates telephone service operated by private companies, G. by the Government, and P.G. by both private companies and the Government. See preceding table.

# March 31, 1932. † June 30, 1931. ‡ U.S.S.R., including Siberia and Associated Republics; partly estimated.

### Telephone Development of Large and Small Communities—January 1, 1932

Country	Service Operated by (See Note)	NUMBER OF TELEPHONES		TELEPHONES PER 100 POPULATION	
		In Communities of 50,000 Population and Over	In Communities of less than 50,000 Population	In Communities of 50,000 Population and Over	In Communities of less than 50,000 Population
Australia (June 30, 1931)*	G.	284,000	214,055	8.6	6.7
Austria (January 1, 1931)	G.	176,153	57,759	7.5	1.3
Belgium (January 1, 1931)	G.	203,106	89,527	6.1	1.9
Canada	P.G.	732,000	632,200	22.8	8.8
Czechoslovakia	P.G.	66,217	102,926	4.0	0.8
Denmark	P.G.	165,662	196,298	18.0	7.3
Finland	P.G.	49,130	78,367	10.6	2.4
France	G.	715,663	513,216	7.8	1.6
Germany (March 31, 1932)	G.	2,017,437	1,096,218	7.6	2.8
Great Britain and No. Ireland#	G.	1,507,500	601,900	5.8	2.9
Hungary	G.	88,288	28,309	5.0	0.4
Japan (March 31, 1932)	G.	565,053	354,552	3.5	0.7
Netherlands	G.	210,451	115,348	6.6	2.4
New Zealand (March 31, 1932)	G.	62,459	98,320	11.9	9.0
Norway (June 30, 1931)	P.G.	67,921	129,334	16.9	5.3
Poland	P.G.	116,248	77,900	2.6	0.3
Spain	P.	147,447	105,053	3.4	0.6
Sweden	G.	224,483	336,122	22.2	6.5
Switzerland	G.	143,921	180,167	16.9	5.6
Union of South Africa	G.	60,313	52,752	6.3	0.7
United States	P.	10,976,449	8,713,738	21.9	11.8

NOTE: P. indicates telephone service operated by private companies, G. by the Government, and P.G. by both private companies and the Government. See first table.  
 \* Partly estimated. # March 31, 1932.

### Telephone Conversations and Telegrams—Year 1931

Country	Number of Telephone Conversations	Number of Telegrams	Total Number of Wire Communications	PER CENT OF TOTAL WIRE COMMUNICATIONS		WIRE COMMUNICATIONS PER CAPITA	
				Telephone Conversations	Telegrams	Telegrams	Total
Australia	4,27,900,000	13,633,000	441,533,000	96.9	3.1	66.1	68.2
Austria (1930)	*550,000,000	2,693,000	552,693,000	99.5	0.5	80.8	81.2
Belgium	227,381,000	*5,400,000	232,781,000	97.7	2.3	27.8	28.5
Canada	2,565,641,000	12,092,000	2,577,733,000	99.5	0.5	249.1	250.3
Czechoslovakia	283,000,000	5,162,000	288,162,000	98.2	1.8	19.1	19.5
Denmark	563,326,000	1,979,000	565,305,000	99.6	0.4	156.6	157.2
Finland	176,000,000	597,000	176,597,000	99.7	0.3	47.6	47.8
France	847,206,000	33,510,000	880,716,000	96.2	3.8	20.1	20.9
Germany	2,376,000,000	19,592,000	2,395,592,000	99.2	0.8	36.6	36.9
Gt. Britain & No. Ireland	1,590,000,000	47,312,000	1,637,312,000	97.1	2.9	34.4	35.4
Hungary	133,100,000	2,600,000	135,700,000	98.1	1.9	15.3	15.6
Japan	3,326,148,000	51,142,000	3,377,290,000	98.5	1.5	50.5	51.3
Netherlands	*530,000,000	4,204,000	534,204,000	99.2	0.8	66.5	67.0
New Zealand	316,843,000	4,647,000	321,490,000	98.6	1.4	197.5	200.4
Norway	261,000,000	3,182,000	264,182,000	98.8	1.2	92.7	93.8
Poland	728,475,000	4,438,000	732,913,000	99.4	0.6	23.0	23.1
Spain*	616,000,000	22,000,000	638,000,000	96.6	3.4	26.8	27.8
Sweden	842,000,000	3,984,000	845,984,000	99.5	0.5	136.9	137.5
Switzerland	251,300,000	3,984,000	255,284,000	99.0	1.0	61.6	62.2
Union of South Africa	200,938,000	4,636,000	205,574,000	97.7	2.3	24.7	25.3
United States	27,500,000,000	185,000,000	27,685,000,000	99.3	0.7	222.0	223.5

NOTE: Telephone conversations represent completed local and toll or long distance messages. Telegrams include inland and outgoing international messages.  
 \* Partly estimated.

TELEPHONE DEVELOPMENT IN THE UNITED STATES AND EUROPE

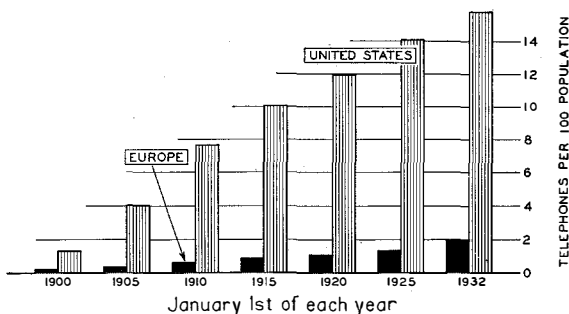

DISTRIBUTION OF THE WORLD'S TELEPHONES January 1, 1932

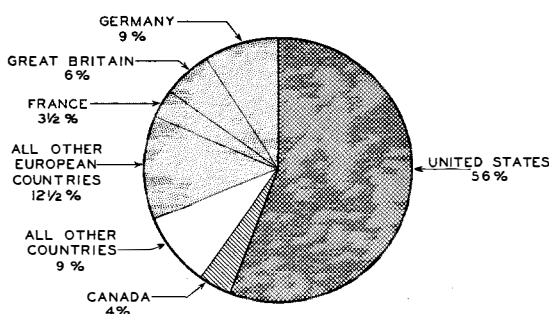



# LOW TENSION RECTIFIERS

***For battery charging and other D.C. supply purposes from 2 amps., 24 volts to 120 amps., 500 volts » »***

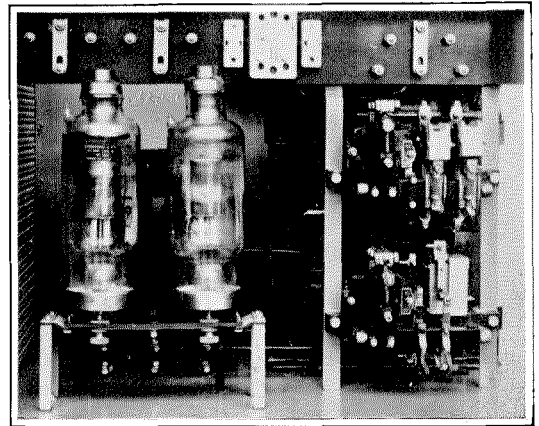

Rectifier 40 amps., 48 volts

Rectifier equipments using hot cathode mercury vapour valves present many advantages of high efficiency and low maintenance costs. Such

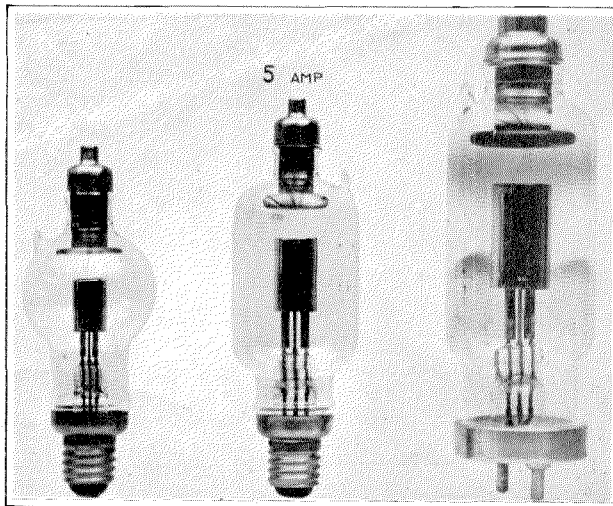

3031-A

3031-B

3031-C

rectifiers have immediate application. For example, to battery charging at telephone exchanges, the output being made suitably free from ripple. Local and remote control facilities are fitted as standard. The valves have long lives and a voltage drop of only 5 volts.

*For full particulars on rectifier equipments and valves, communicate with*

## *Le Matériel Téléphonique*

46 & 47 Quai de Boulogne—BOULOGNE—BILLANCOURT—FRANCE

Telephone: Auteuil 90-00—Molitor 11-91

# Power and Efficiency

The 3017-E hot cathode mercury vapour rectifier valve enables efficiencies of the order of 96% to be obtained from high tension rectifier equipments suitable for feeding the anode of the 3030-A transmitting valve or any other type of high power valve.

The 3030-A transmitting valve is rated at 120 KW output with 20,000 volts on the anode. This type of valve is being used on the most modern high power broadcasting equipments in Europe.

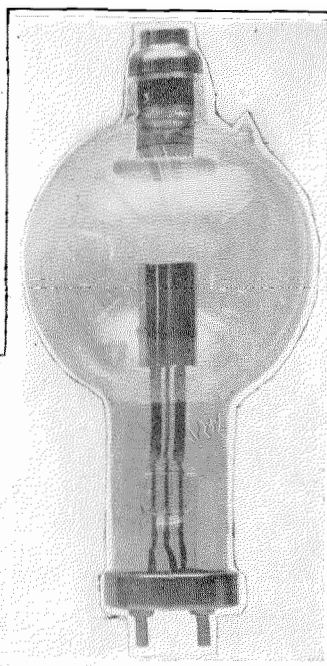
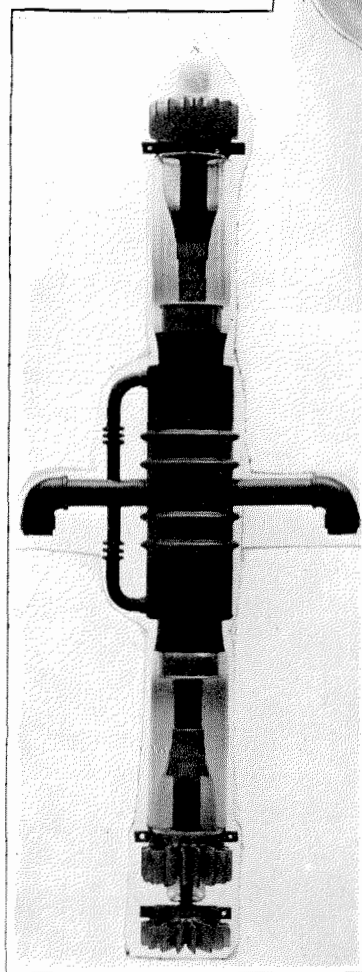

*Above. The 3017-E hot cathode mercury vapour rectifier valve.*

*At left. The 3030-A transmitting valve.*

*Full particulars on these valves and similar types available on request from*

***Le Matériel Téléphonique***

46 & 47 Quai de Boulogne—BOULOGNE—BILLANCOURT—FRANCE

Telephone: Auteuil 90-00—Molitor 11-91

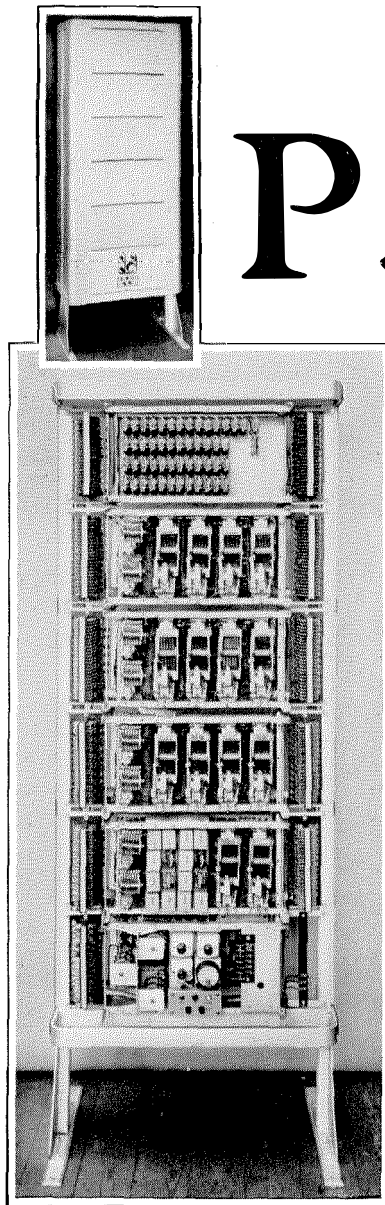

No. 7030—P.A.B.X. Open. Inset at top shows No. 7030 P.A.B.X. Closed.

# The No. 7030 P. A. B. X.

In this novel equipment designed for capacities of 25-99 lines, the latest developments in public exchange equipment are applied to the requirements of business organizations.

The No. 7030 P.A.B.X. is built on the unit principle, and the self-contained and interchangeable units are mounted on floor type racks and are completely enclosed.

The compact design provides accommodation for a large number of lines in a small space. The adoption of the unit principle of construction permits easy alteration of the equipment to meet changed requirements. Boards with almost any combination of circuits can be built with practically no changes in framework and cabling.

As space for the 24-volt power equipment is provided in the switchboard itself, the No. 7030 P.A.B.X. is virtually self-contained.

Outgoing calls and local calls between P.A.B.X. stations are entirely automatic.

Incoming calls are handled by the attendant, whose station apparatus is little larger than the normal type table telephone set.

*Particulars are obtainable from:*

**BELL TELEPHONE MANUFACTURING COMPANY**

**4 Rue Boudewyns, Antwerp, Belgium**

or from any of the Companies listed on the inside rear cover.

# SAFETY AT SEA

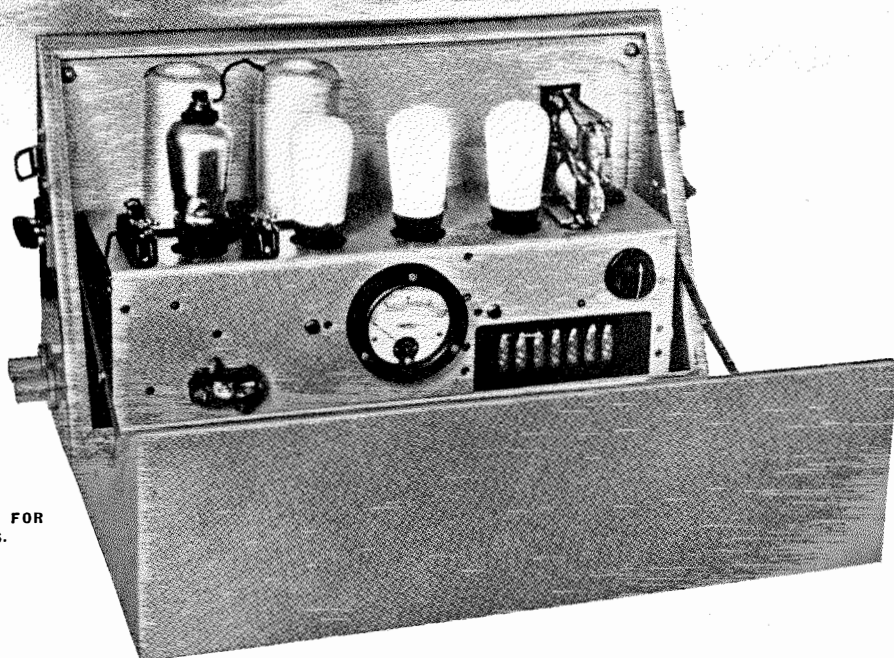

AUTOMATIC RECEIVER FOR  
DISTRESS SIGNALS.

## 1933 AUTO-ALARM EQUIPMENT

APPROVED FOR INSTALLATION ON BRITISH SHIPS.

The International Marine Radio Company's Auto-Alarm Type A.A.2 is the latest Auto-Alarm to be tested and approved by the Post Office and the Board of Trade for installation on board British ships.

**This new equipment is now available at a lower figure—either for sale or rental—than any other auto-alarm at present supplied to ship-owners.**

The Designers of this equipment, who are Engineers well-known in connection with the manufacture of Automatic Telephone Apparatus, have applied the experience obtained with Telephone Subscribers' Automatic Circuits in all parts of the World to produce this Auto-Alarm Equipment.

***Simpler and more reliable than any other type. Shipowners are strongly advised to ask us for competitive prices prior to completing new radio contracts or renewing existing agreements.***

Write to us and ask for a description of the equipment and the tests to which it was submitted.

SELECTOR FOR  
DISTRESS SIGNALS.

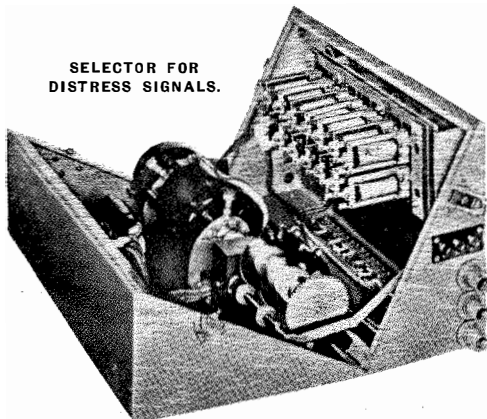

**INTERNATIONAL MARINE RADIO CO. Ltd.**  
Connaught House, London, W.C. 2

## INTERNATIONAL TELEPHONE AND TELEGRAPH CORPORATION

### BOARD OF DIRECTORS

<p>ARTHUR M. ANDERSON J. P. Morgan &amp; Co.</p> <p>HERNAND BEHN, President</p> <p>SOSTHENES BEHN, Chairman</p> <p>F. WILDER BELLAMY Dominick &amp; Dominick</p> <p>EDWARD J. BERWIND Chairman, Berwind-White Coal Mining Company</p> <p>EDWIN F. CHINLUND, Vice-President and Comptroller</p> <p>PHILIP K. CONDUCT Executive Vice-President, International Standard Electric Corporation</p> <p>JOHN W. CUTLER Edward B. Smith &amp; Co.</p> <p>R. FULTON CUTTING Financier</p> <p>GEORGE H. GARDINER Davis Polk Wardwell Gardiner &amp; Reed</p> <p>GEORGE S. GIBBS President, Postal Telegraph and Cable Corporation</p> <p>A. H. GRISWOLD Executive Vice-President, Postal Telegraph and Cable Corporation</p>	<p>ALLEN G. HOYT Vice-President, The National City Bank of New York</p> <p>RUSSELL C. LEFFINGWELL J. P. Morgan &amp; Co.</p> <p>CLARENCE H. MACKAY Chairman of the Board, Postal Telegraph and Cable Corporation</p> <p>JOHN L. MERRILL President, All America Cables, Incorporated</p> <p>WALTER E. OGILVIE President, Havana Terminal Railroad Company</p> <p>HENRY B. ORDE President, Shanghai Telephone Company</p> <p>BRADLEY W. PALMER Chairman of the Executive Committee, United Fruit Company, Boston</p> <p>GEORGE E. PINGREE President, International Standard Electric Corporation</p> <p>WOLCOTT H. PITKIN, Vice-President and General Attorney</p> <p>LEWIS J. PROCTOR, Vice-President</p> <p>LANSING P. REED Davis Polk Wardwell Gardiner &amp; Reed</p>
--	---

GEORGE H. GARDINER  
General Counsel

### OFFICERS

<i>Chairman</i> SOSTHENES BEHN	<i>President</i> HERNAND BEHN	
<i>Vice-Presidents</i>	<i>Vice-Presidents</i>	<i>Vice-Presidents</i>
LEWIS J. PROCTOR GEORGE E. PINGREE PHILIP K. CONDUCT	JOHN L. MERRILL FRANK W. PHELAN WILLIAM F. REPP A. H. GRISWOLD	FRANK C. PAGE LOGAN N. ROCK GEORGE S. GIBBS
<i>Vice-President and General Attorney</i> WOLCOTT H. PITKIN	<i>Vice-President and General Technical Director</i> GERALD DEAKIN	<i>Vice-President and Comptroller</i> EDWIN F. CHINLUND
<i>Secretary</i> SAMUEL G. ORDWAY		<i>Treasurer</i> JOSEPH A. REDEGELD

**T**HE International Telephone and Telegraph Corporation was organized to cooperate and assist technically and financially in the general development of electrical communications in a broad international sense, and, with respect to the organization and development of national communications systems, it is the purpose of the International Telephone and Telegraph Corporation to develop truly national systems operated by the nationals of each country in which the International Corporation is or may become interested. The International Corporation was not organized with the desire of imposing American practices in its foreign activities. There appeared

to be a fruitful field of service to be rendered in bringing together under one general organization electrical communications systems, and the extension, by the International Corporation to the associated companies, of the technical and financial facilities and direction that might be needed for their intensive and efficient development. The best American practices have been suggested but never imposed. On the contrary, the International Corporation has always been ready and quick to adjust American practices to local conditions and to adopt such local practices as were conducive to the successful development of the various entities.

---

---

## *Licensee Companies*

- BELL TELEPHONE MANUFACTURING COMPANY..... *Antwerp, Belgium*  
*Branches: Brussels.*
- BELL TELEPHONE MANUFACTURING COMPANY..... *Berne, Switzerland*
- BELL TELEPHONE MANUFACTURING COMPANY..... *The Hague, Holland*
- STANDARD ELECTRIC DOMS A SPOLECNOST..... *Prague, Czechoslovakia*  
*Branch: Bratislava.*
- CHINA ELECTRIC COMPANY, LIMITED..... *Shanghai, China*  
*Branches: Canton, Hankow, Harbin, Hongkong, Peiping, Tientsin.*
- COMPAÑÍA STANDARD ELECTRIC ARGENTINA..... *Buenos Aires, Argentina*
- INTERNATIONAL STANDARD ELECTRIC CORPORATION, *Branch Office,*  
*Rio de Janeiro, Brazil*
- LE MATERIEL TÉLÉPHONIQUE..... *Paris, France*  
*Rabat, Morocco*
- NIPPON DENKI KABUSHIKI KAISHA..... *Tokyo, Japan*  
*Branches: Osaka, Dairen, Taihoku.*
- FERDINAND SCHUCHHARDT, BERLINER FERNSPRECH-UND TELEGRAPHENWERK  
AKTIENGESELLSCHAFT..... *Berlin, Germany*
- STANDARD ELECTRIC AKTIESELSKAB..... *Copenhagen, Denmark*
- STANDARD ELECTRIC AKTIESELSKAP..... *Oslo, Norway*
- AKTIESELSKABET SKANDINAVISKE KABEL- OG GUMMIFABRIKER..... *Oslo, Norway*
- STANDARD ELECTRIC COMPANY W POLSCE SP. Z. O. O..... *Warsaw, Poland*
- STANDARD ELECTRICA ROMANA S/A..... *Bucharest, Rumania*
- STANDARD ELÉCTRICA, S. A..... *Madrid, Spain*  
*Branches: Barcelona, Santander.*
- STANDARD ELECTRICA, S. A..... *Lisbon, Portugal*
- STANDARD ELETTRICA ITALIANA..... *Milan, Italy*  
*Branch: Rome.*
- STANDARD TELEPHONES AND CABLES, LIMITED..... *London, England*  
*Branches: Birmingham, Glasgow, Leeds, Manchester, Dublin, Cairo, Johannes-  
burg, Calcutta, Singapore.*
- STANDARD TELEPHONES AND CABLES (AUSTRALASIA), LIMITED..... *Sydney, Australia*  
*Branches: Melbourne, Wellington.*
- STANDARD VILAMOSÁGI RÉSZVÉNY TÁRSASÁG..... *Budapest, Hungary*
- SUMITOMO ELECTRIC WIRE & CABLE WORKS, LIMITED..... *Osaka, Japan*
- ÖSTERREICHISCHE TELEPHON-FABRIK AKTIENGESELLSCHAFT..... *Vienna, Austria*
- VEREINIGTE TELEPHON-UND TELEGRAPHENFABRIKS AKTIEN-GESELLSCHAFT,  
CZEIJA, NISSL & CO..... *Vienna, Austria*

---

*Sales Offices and Agencies Throughout the World*

---

---